

TR NEWS

A Worldwide Car Culture *Can It Be Sustainable?*

Plus

**Repairing Bridges with
Sense and Sensitivity**

**New Clues for
Highway Safety**

**Transit's Role in
Evacuation**



THE NATIONAL ACADEMIES

Advisers to the Nation on Science, Engineering, and Medicine

National Academy of Sciences National Academy of Engineering Institute of Medicine National Research Council

The **Transportation Research Board** is one of six major divisions of the National Research Council, which serves as an independent adviser to the federal government and others on scientific and technical questions of national importance, and which is jointly administered by the National Academy of Sciences, the National Academy of Engineering, and the Institute of Medicine. The mission of the Transportation Research Board is to provide leadership in transportation innovation and progress through research and information exchange, conducted within a setting that is objective, interdisciplinary, and multimodal. The Board's varied activities annually engage about 7,000 engineers, scientists, and other transportation researchers and practitioners from the public and private sectors and academia, all of whom contribute their expertise in the public interest. The program is supported by state transportation departments, federal agencies including the component administrations of the U.S. Department of Transportation, and other organizations and individuals interested in the development of transportation.

The **National Research Council** was organized by the National Academy of Sciences in 1916 to associate the broad community of science and technology with the Academy's purposes of furthering knowledge and advising the federal government. Functioning in accordance with general policies determined by the Academy, the Council has become the principal operating agency of both the National Academy of Sciences and the National Academy of Engineering in providing services to the government, the public, and the scientific and engineering communities.

www.TRB.org

TRANSPORTATION RESEARCH BOARD 2008 EXECUTIVE COMMITTEE*

Chair: Debra L. Miller, Secretary, Kansas Department of Transportation, Topeka
Vice Chair: Adib K. Kanafani, Cahill Professor of Civil Engineering, University of California, Berkeley
Executive Director: Robert E. Skinner, Jr., Transportation Research Board

J. Barry Barker, Executive Director, Transit Authority of River City, Louisville, Kentucky
Allen D. Biehler, Secretary, Pennsylvania Department of Transportation, Harrisburg
John D. Bowe, President, Americas Region, APL Limited, Oakland, California
Larry L. Brown, Sr., Executive Director, Mississippi Department of Transportation, Jackson
Deborah H. Butler, Executive Vice President, Planning, and CIO, Norfolk Southern Corporation, Norfolk, Virginia
William A. V. Clark, Professor, Department of Geography, University of California, Los Angeles
David S. Ekern, Commissioner, Virginia Department of Transportation, Richmond
Nicholas J. Garber, Henry L. Kinnier Professor, Department of Civil Engineering, University of Virginia, Charlottesville
Jeffrey W. Hamiel, Executive Director, Metropolitan Airports Commission, Minneapolis, Minnesota
Edward A. (Ned) Helme, President, Center for Clean Air Policy, Washington, D.C.
Will Kempton, Director, California Department of Transportation, Sacramento
Susan Martinovich, Director, Nevada Department of Transportation, Carson City
Michael D. Meyer, Professor, School of Civil and Environmental Engineering, Georgia Institute of Technology, Atlanta (Past Chair, 2006)
Michael R. Morris, Director of Transportation, North Central Texas Council of Governments, Arlington
Neil J. Pedersen, Administrator, Maryland State Highway Administration, Baltimore
Pete K. Rahn, Director, Missouri Department of Transportation, Jefferson City
Sandra Rosenbloom, Professor of Planning, University of Arizona, Tucson
Tracy L. Rosser, Vice President, Corporate Traffic, Wal-Mart Stores, Inc., Bentonville, Arkansas
Rosa Clausell Rountree, Consultant, Tyrone, Georgia
Henry G. (Gerry) Schwartz, Jr., Chairman (retired), Jacobs/Sverdrup Civil, Inc., St. Louis, Missouri
C. Michael Walton, Ernest H. Cockrell Centennial Chair in Engineering, University of Texas, Austin (Past Chair, 1991)
Linda S. Watson, CEO, LYNX—Central Florida Regional Transportation Authority, Orlando (Past Chair, 2007)
Steve Williams, Chairman and CEO, Maverick Transportation, Inc., Little Rock, Arkansas
Thad Allen (Adm., U.S. Coast Guard), Commandant, U.S. Coast Guard, Washington, D.C. (ex officio)
Rebecca M. Brewster, President and COO, American Transportation Research Institute, Smyrna, Georgia (ex officio)
Paul R. Brubaker, Administrator, Research and Innovative Technology Administration, U.S. Department of Transportation (ex officio)
George Bugliarello, President Emeritus and University Professor, Polytechnic Institute of New York University, Brooklyn; Foreign Secretary, National Academy of Engineering, Washington, D.C. (ex officio)
Sean T. Connaughton, Administrator, Maritime Administration, U.S. Department of Transportation (ex officio)
Clifford C. Eby, Acting Administrator, Federal Railroad Administration, U.S. Department of Transportation (ex officio)
LeRoy Gishi, Chief, Division of Transportation, Bureau of Indian Affairs, U.S. Department of the Interior, Washington, D.C. (ex officio)
Edward R. Hamberger, President and CEO, Association of American Railroads, Washington, D.C. (ex officio)
John H. Hill, Administrator, Federal Motor Carrier Safety Administration, U.S. Department of Transportation (ex officio)
John C. Horsley, Executive Director, American Association of State Highway and Transportation Officials, Washington, D.C. (ex officio)
Carl T. Johnson, Administrator, Pipeline and Hazardous Materials Safety Administration, U.S. Department of Transportation, Washington, D.C. (ex officio)
David Kelly, Acting Administrator, National Highway Traffic Safety Administration, U.S. Department of Transportation (ex officio)
Sherry E. Little, Acting Administrator, Federal Transit Administration, U.S. Department of Transportation (ex officio)
Thomas J. Madison, Jr., Administrator, Federal Highway Administration, U.S. Department of Transportation (ex officio)
William W. Millar, President, American Public Transportation Association, Washington, D.C. (ex officio) (Past Chair, 1992)
Robert A. Sturgell, Acting Administrator, Federal Aviation Administration, U.S. Department of Transportation (ex officio)
Robert L. Van Antwerp (Lt. General, U.S. Army), Chief of Engineers and Commanding General, U.S. Army Corps of Engineers, Washington, D.C. (ex officio)

* Membership as of December 2008.

TR NEWS

NUMBER 259

NOVEMBER–DECEMBER 2008

3 Two Billion Cars: Transforming a Culture

Daniel Sperling and Deborah Gordon

While providing untold benefits, today's one billion motorized vehicles are contributing to worldwide problems with energy resources, climate change, and congestion. The number of vehicles is expected to reach two billion by 2020. In tracing out the complexity of problems and solutions, the authors call on the transportation community to summon its ingenuity to improve vehicles and fuels, introduce new mobility, and develop ways to alter travel behaviors.

10 Context-Sensitive and Sustainable Solutions for Transportation: Oregon's Bridge Delivery Program Model

Thomas Lauer

Oregon's 10-year State Bridge Delivery Program is garnering awards for successful innovations to stimulate the state economy and develop a skilled workforce; employ cost-effective practices; maintain freight and traffic mobility; build with sensitivity to the needs of communities and the environment; and capitalize on funding opportunities.

18 Creating a Culture of Traffic Safety: Learning from Four States with Improved Safety Records

Betty J. Mercer

Although the rate of traffic-related fatalities is increasing nationwide, some states are achieving continual improvements in highway safety. Case studies show that these states share a key characteristic—the development of a statewide traffic safety culture. The case studies yield practical pointers for other states seeking to make similar strides in reducing fatalities and serious injuries on the roadways.

21 NEW TRB SPECIAL REPORT The Role of Transit in Emergency Evacuation

Nancy Humphrey

Transit can play a vital role in an emergency evacuation. A concerted local, state, and federal effort is needed to realize this potential, however, according to a new study requested by Congress. Focusing on transit systems in the nation's 38 largest urbanized areas, the report explores the roles that transit systems can play in accommodating the evacuation, egress, and ingress of people to or from critical locations during an evacuation of a central business district.

The Transportation Research Board's 2008 Annual Report is included in this issue as a special insert between pages 18 and 19.



3



10



18

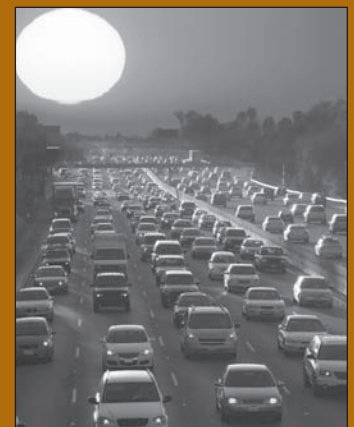

COVER: With car ownership and use expanding worldwide, research and innovation are needed to find sustainable ways to address the environmental and geopolitical impacts of motor vehicles.

TR NEWS

features articles on innovative and timely research and development activities in all modes of transportation. Brief news items of interest to the transportation community are also included, along with profiles of transportation professionals, meeting announcements, summaries of new publications, and news of Transportation Research Board activities.

TR News is produced by the Transportation Research Board Publications Office

Javy Awan, Editor and Publications Director
Christopher R. D'Amore, Assistant Editor
Jennifer J. Weeks, Photo Researcher
Juanita Green, Production Manager
Michelle Wandres, Graphic Designer

TR News Editorial Board

Neil F. Hawks, Chairman
Charles Fay
Edward T. Harrigan
Christopher J. Hedges
Frederick D. Hejl
Thomas R. Menzies, Jr.
Mark R. Norman
Barbara L. Post

Transportation Research Board

Robert E. Skinner, Jr., Executive Director
Suzanne B. Schneider, Associate Executive
Director
Mark R. Norman, Director,
Technical Activities
Stephen R. Godwin, Director,
Studies and Special Programs
Michael P. LaPlante, Director,
Administration and Finance
Christopher W. Jenks, Director,
Cooperative Research Programs
Neil F. Hawks, Director, SHRP 2

TR News (ISSN 0738-6826) is issued bimonthly by the Transportation Research Board, National Research Council, 500 Fifth Street, NW, Washington, DC 20001. Internet address: www.TRB.org.

Editorial Correspondence: By mail to the Publications Office, Transportation Research Board, 500 Fifth Street, NW, Washington, DC 20001, by telephone 202-334-2972, by fax 202-334-3495, or by e-mail jawan@nas.edu.

Subscriptions: North America: 1 year \$55; single issue \$10. Overseas: 1 year \$80; single issue \$14. Inquiries or communications concerning new subscriptions, subscription problems, or single-copy sales should be addressed to the Business Office at the address below, or telephone 202-334-3216, fax 202-334-2519. Periodicals postage paid at Washington, D.C.

Postmaster: Send changes of address to *TR News*, Transportation Research Board, 500 Fifth Street, NW, Washington, DC 20001.

Notice: The opinions expressed in articles appearing in *TR News* are those of the authors and do not necessarily reflect the views of the Transportation Research Board. The Transportation Research Board and *TR News* do not endorse products or manufacturers. Trade and manufacturers' names appear in an article only because they are considered essential to its object.

Printed in the United States of America.

Copyright © 2008 Transportation Research Board. All rights reserved.

ALSO IN THIS ISSUE:

25 Research Pays Off Fighting Fatigue in Steel Bridges: Kansas Bridge Design Engineers Guide Research Solutions into Practice

*John Patrick Jones, Caroline Bennett, Adolfo Matamoros,
Stan Rolfe, and Kim Roddis*

27 Calendar

28 Profiles

Aviation consultant James A. Wilding and traffic operations and management expert Robert B. (Tip) Franklin

30 News Briefs

31 TRB Highlights

Cooperative Research Programs News, 31

32 Bookshelf

COMING NEXT ISSUE

An account of foundational developments for research in the capacity focus area of the Strategic Highway Research Program 2—establishing a collaborative decision-making framework—is the subject of a feature article in the January–February *TR News*. The issue also contains an overview of a policy study on the priorities, coordination, and quality of safety research in highway infrastructure and operations; summaries of reports about research needs and innovative applications at state departments of transportation—findings from the field visits by TRB Technical Activities Division senior staff; and more.



The January–February Research Pays Off column describes improved lighting for nighttime construction, as applied by the Illinois Department of Transportation.

Two Billion Cars

Transforming a Culture

DANIEL SPERLING AND DEBORAH GORDON

Sperling is Founding Director, Institute of Transportation Studies, and Professor of Engineering and Environmental Science and Policy, University of California, Davis. He is a member of the TRB Special Task Force on Climate Change and Energy, the Transportation and Sustainability Committee, and the Committee for a Study of Potential Energy Savings and Greenhouse Gas Reductions from Transportation, and an emeritus member of the Alternative Transportation Fuels Committee. Gordon is a transportation policy and energy analyst and consultant, a past member of the TRB Energy Committee, and a recipient of the TRB Fred Burggraf Award.



This article is adapted from Two Billion Cars: Driving Toward Sustainability, by Sperling and Gordon, to be published by Oxford University Press in 2009. For statistics cited in this article and for references to source materials, please see Two Billion Cars.

More than one billion motorized vehicles are driven on the earth today. The United States, birthplace of the car industry and car culture, leads in the numbers of vehicles.¹ In the next two decades, vehicle ownership is expected to double worldwide (Figure 1, next page).

Can the planet sustain two billion vehicles? No—at least not as they exist today. Today's billion vehicles are pumping extraordinary quantities of greenhouse gases into the atmosphere, are draining the world's conventional petroleum supplies, are inciting political skirmishes over oil, and are overwhelming city roads. Even in the most conservative view, conventional motorization, vehicles,

and fuels threaten an economic and environmental cataclysm.

Cars will not disappear. The desire for personal vehicles is powerful and pervasive. Cars offer unprecedented freedom, flexibility, convenience, and comfort. Cars bestow untold benefits on their owners. Cars have transformed modern life and are one of the great industrial success stories of the 20th century (Figure 2, next page).

Editor's Note: The spotlight theme for the TRB 2009 Annual Meeting is Transportation, Energy, and Climate Change. The 70 sessions and workshops addressing this theme offer a myriad of research results and perspectives; this feature article serves as a preview. TR News invites articles and letters to the editor about research and perspectives on energy and climate change to continue the focus on these issues.

¹ The term cars often is used here to represent all conventional motor vehicles—cars, sport utility vehicles, minivans, trucks, buses, motorcycles, scooters, or three-wheeled motorized vehicles.

FIGURE 1 Historical and projected increases in global motor vehicle population, 1950–2030 (1).

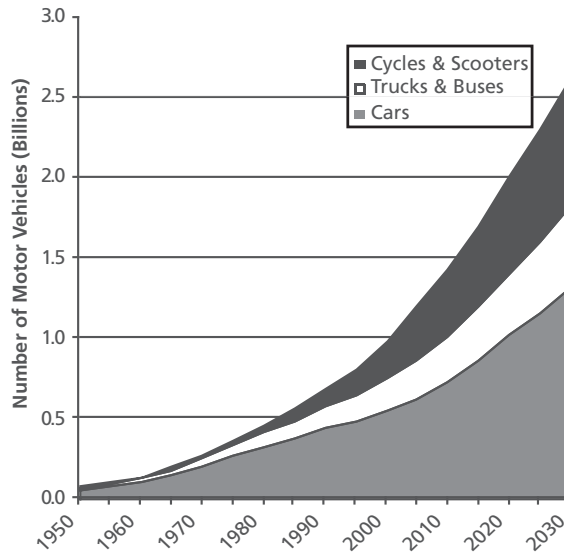

Troublesome Trends

Vehicle Ownership

Despite the rhetoric about energy independence and climate stabilization, vehicle sales, oil consumption, and carbon dioxide emissions are soaring globally. The number of motorized vehicles around the world is expected to increase by 3 percent annually. The slowest rate of car growth is expected in Europe, at less than 1 percent per year; in the United States, the rate will be likely 1 to 2 percent; but in China and

India, growth rates of more than 7 or 8 percent per year are expected (2).

Ever-cheaper cars are whetting the powerful desire for personal vehicles. The Indian conglomerate Tata plans to unveil the \$2,500 Nano soon. Most international automakers will follow, manufacturing cheap cars not only for the developing world but also for richer countries.

Increasing vehicle ownership translates into increasing oil use. The world consumes 85 million barrels of oil per day, and demand is expected to reach 120 million barrels by 2030. One-fourth of all the oil consumed by humans throughout history will be consumed during the next 10 years.

With oil production outside of the Organization of Petroleum Exporting Countries (OPEC) already near peak, the United States and other countries will rely increasingly on OPEC supplies, creating stress as countries compete for ever scarcer petroleum resources. With transportation accounting for one-half of all oil consumption in the world and for two-thirds in the United States, the oil problem is largely a transportation problem.

Climate Change

Climate change poses another problem. The scientific community believes that greenhouse gas emissions, especially carbon dioxide (CO₂), need to be reduced by 50 to 80 percent by 2050 to stabilize the climate and to avert economic and environmental cataclysm (3). Transportation-related CO₂ emissions have more than doubled since 1970, a faster rate of growth than emissions from any other sector. In the United States, transportation contributes one-third of CO₂ emissions.

In 2008, for the first time, greenhouse gas emissions from transportation did not increase in the United States, after annual increases of approximately 2 percent during the preceding decades. Transportation-related petroleum use and greenhouse gas emissions likely will level off and slowly begin to decrease in the next few years—because of improvements in vehicle fuel economy—but U.S. oil imports still will be extraordinarily high, and greenhouse gas emissions will not approach the stabilization goal of a 50 to 80 percent reduction.

Car companies are evolving quickly, prodded by high oil prices, aggressive energy and climate policies, and shifts in consumer preferences. The era of large sport utility vehicles is receding, with smaller and more efficient vehicles moving to the fore, and electric-drive propulsion slowly gaining adoption. Policies to improve fuel economy and reduce carbon emissions face resistance from many, but change is at hand.

1859	First U.S. oil well discovered
First internal combustion engine car built by Karl Benz	1885
1908	Model T, with internal combustion engine, debuts
U.S. transit ridership reaches highest peacetime levels	1926
1930	Car ownership reaches 200 for every 1,000 Americans
Suburban building boom begins after World War II	1947
1956	U.S. Interstate Highway System launched
Arab oil embargo constricts supply	1973
1979	Iran-Iraq war doubles oil prices
First hybrid-electric cars sold in U.S.	2000
2003	Car ownership reaches 1.15 vehicles per American driver
Motor vehicle numbers worldwide exceed 1 billion	2005
2008	Crude oil priced at \$140 a barrel

FIGURE 2 Brief history of car-centric transportation (1).



PHOTO: TIM BEREKS

Air pollution over Hong Kong, China. The city's roads are among the most crowded in the world, with approximately 280 vehicles per road kilometer. Diesel commercial vehicles produce 90 percent of particulate matter and 80 percent of nitrogen oxide emissions from the road sector. The dense population, factories, power stations, and construction also contribute.

Fuel Supply

Fuel supply is more problematic. Prices in global oil markets have little relationship to production costs, and national oil companies in the Middle East, Venezuela, and elsewhere control more than 80 percent of all oil reserves. ExxonMobil, the largest investor-owned Western oil company, ranks 12th in the oil reserves it controls, far behind Saudi Aramco and many others. Many of the politicized national oil companies in OPEC provide more than half their governments' revenue and are more responsive to domestic priorities than to market prices.

As a result, the market is not working. High oil prices are not stimulating investments in oil production or in alternative fuels. With carbon emissions still largely ignored, the Western oil companies are turning to high-carbon unconventional oil—such as tar sands, heavy oil, and even shale oil and coal liquids—investments that may be rational in the market but are not in the public interest.

Traffic Congestion

Vehicle travel has outpaced population growth, even in the United States (Figure 3, page 6). More cars mean more traffic—road construction cannot keep pace with growing mobility demands. In 2008, after five years of steadily increasing gasoline prices, vehicle travel finally did not increase for the first time in decades. Yet car use worldwide is booming, as incomes increase and vehicle costs shrink.

Despite a few innovative alternatives—such as carsharing, pioneered in Switzerland; telecommuting and carpooling, in the United States; and bus rapid transit, in Curitiba, Brazil—cars dominate the transportation system. This hegemony of cars encourages

low-density suburban development. With growth, the suburbs become too dense for cars but not dense enough for mass transit.

Cities that developed with autos—for example, Los Angeles, Houston, and Phoenix—consist of suburbs with small commercial districts. They are not easily served by conventional bus and rail transit with fixed routes and schedules and have difficulty shifting citizens out of cars. Transit accounts for only 2 percent of passenger miles traveled in the United States.

Yet the solutions to oil security and climate change also can resolve local air pollution, traffic congestion, and urban livability. Some traffic congestion is desirable—the absence of congestion would indicate a depressed economy, a somnolent society, or an overinvestment in infrastructure. But congestion levels in most large cities of the world are severe enough to harm economic and social activity. The need to address traffic congestion and escalating infrastructure costs could engage the transportation community in reducing oil use and greenhouse gas emissions.

Road Map to Survival

The world can accommodate two billion or more vehicles, but a transformation of the auto and oil industries—and eventually, of transportation systems—will be required.

Transforming Vehicles

The year 2008 likely will be seen as a turning point in vehicle energy use. Although the energy efficiency of vehicles has been improving steadily, in terms of work per unit of energy, the gains have been applied for more than two decades to increasing vehicle size and power. In other words, the efficiency innovations



Tata Motors factory in Singur, West Bengal, India, was set to produce the inexpensive Nano (above); the site was moved late in 2008 to the state of Gujarat after massive opposition from displaced farmers.



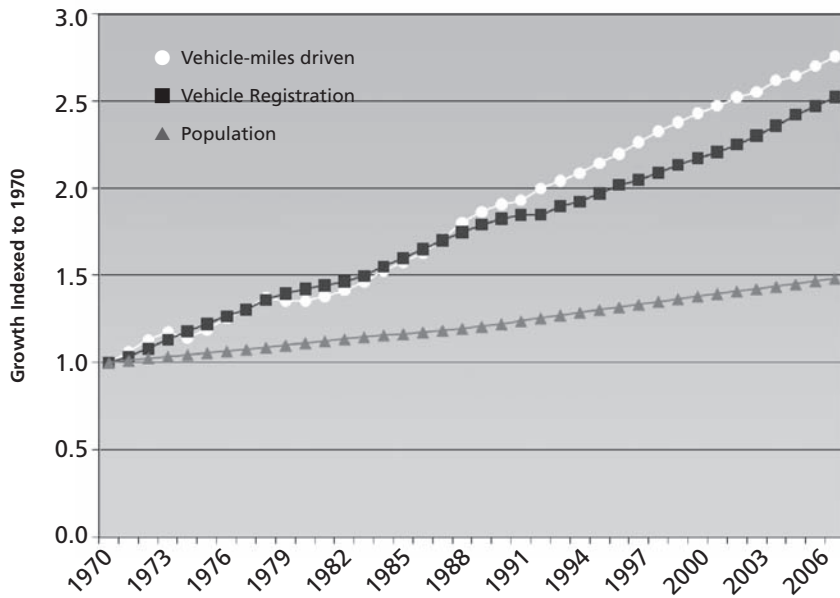

FIGURE 3 Growth of vehicle miles traveled, vehicle registration, and population in the United States since 1970 (2, Tables 3.3, 3.4, and 8.1).

Open pit mining of tar sands—or bituminous sands—in Alberta, Canada; the complex recovery processes include extracting and separating the bitumen from clay, sand, and water (see *photo, lower right*); upgrading before refining, and then diluting with lighter hydrocarbons to make the oil transportable by pipelines.

have served private desires for larger and more powerful vehicles, not the public interests of energy security and climate stabilization.

Change is on the way. In December 2007, Congress passed a law to improve the fuel economy of new cars and light trucks by 40 percent by 2020. California has a pending law to reduce greenhouse gases and fuel consumption still further, and 12 other states are ready to follow. Near-term reductions in energy use and in greenhouse gas emissions will result mainly from improvements in conventional technology—in engines, transmissions, aerodynamics, and materials.

The more profound change is to electric-drive technology. Although 97 percent of the vehicles in the world burn petroleum fuels in combustion engines, electric motors will propel an increasing proportion of vehicles. Hybrid electric vehicles, like the Toyota Prius, are the vanguard of this revolution.

How the electricity will be provided to these vehicles remains uncertain. The two likeliest options are fuel cells that convert hydrogen to electricity and batteries that store electricity from the grid. The transformation of vehicles to electric-drive propulsion is under way, with several automakers planning to release next-generation plug-in hybrids and battery electric vehicles in 2010.

Transforming Fuels

Fuel suppliers and fuels are the next focus for transformation. Except for ethanol in Brazil, alternative fuels have not dislodged or even competed with petroleum fuels, although alternative fuels have spurred improvements indirectly in conventional fuels and engines. In the late 1980s and early 1990s, the anticipated introduction of alternative fuels played a central role in the development of cleaner gasoline and diesel fuels and cleaner-burning engines. The demonstrated viability of methanol and natural gas vehicles—and their lower emissions—provided air quality regulators with a sound basis for tightening fuel and vehicle standards.

More profound changes are under consideration. The dominant transportation fuels of the future will be a mix of biofuels, electricity, and hydrogen. Electricity and hydrogen will fuel electric-drive vehicles, with biofuels gradually replacing petroleum fuels in combustion engines—probably including jet engines.

The debate over biofuels has focused on ethanol made from corn. But corn ethanol is not an attractive option for the long term—nor, according to many, for the short term—for a variety of economic and envi-



A separation cell is one step in the extraction of bitumen from tar sands mixed with water.



Traffic congestion in Hyderabad, India—“Traffic Jams a Way of Life Now,” according to an Indian newspaper headline.

ronmental reasons. The other prominent biofuel, ethanol made from sugarcane in Brazil, is more attractive, but Brazil's circumstances are unique and are not likely to be replicated elsewhere. The future of biofuels is promising, but the principal fuel produced from biomass will not be ethanol, and the principal feedstock will not be corn.

Most biofuels of the future probably will be made from cellulosic waste materials—grasses, trees, crop and forestry residues, and municipal waste—and converted into fuels that resemble gasoline and diesel. Ethanol will be phased out, because it has lower energy densities and is not compatible with the gasoline distribution system already in place—ethanol distribution is expensive and inefficient, relying mostly on rail cars instead of pipelines.

The imperative for alternative fuels is not that the world is running out of oil, but that it is running out of conventional oil. Tomorrow's oil resources will be different from today's. The 20th century was fueled by easily accessible, relatively cheap, conventional oil. Most of the remaining conventional oil comes from the Persian Gulf countries of OPEC. Those supplies not only are insecure but are inadequate. Oil companies therefore are developing unconventional fossil resources—such as tar sands, oil shale, tarlike heavy oil, and coal. The unconventional oil is dirtier, requires more energy to extract, and is more carbon-intensive than conventional oil.

The oil industry excels at assembling capital to build and operate complex facilities and therefore

favors high-carbon fuels. Unless the risk and cost of low-carbon alternative fuels are reduced, the fuels of the future will be predominantly high-carbon unconventional oil.

The question is whether oil companies will invest their profits to deliver a new array of low-carbon transportation fuels. For this to occur, the oil companies would have to transform themselves into broader energy companies that supply not only petroleum fuels but also biofuels, hydrogen, and possibly electricity.

Transforming Mobility

Relying solely on auto technology and fuels to reduce oil use and greenhouse gas emissions dramatically would be hugely expensive—in part because of continuing growth in vehicle use. If the historical growth in vehicle miles traveled were to prevail, today's 3 trillion vehicle miles in the United States would more than double by 2050. Slowing or stopping this growth in vehicle use while still meeting the desire for accessibility is a tremendous challenge that will necessitate changes in the transportation culture.

The key to change is greater choice for travelers. Wide-scale use of information and wireless technologies in the transportation sector is imperative. These are needed to facilitate innovations such as smart paratransit, intelligent carsharing, dynamic ridesharing, and the use of telecommunications to rationalize and even replace tripmaking. Choices can be expanded through better land use management,

Hybrid powertrain in a Mercedes Benz Vision GLK, a four-cylinder diesel engine with an electric motor module that acts as a generator and starter. The manufacturer claims that the “luxury class” vehicle achieves “the world’s lowest CO₂ emissions in the SUV segment.”



neighborhood cars, and enhanced mass transit. The availability of these choices will reduce vehicle use and create a lower carbon transportation system.

Traditional solutions will not suffice. The old trains and buses of half a century ago will not solve energy and climate problems, at least in affluent nations. With their low ridership, transit buses in the United States are actually less energy efficient than car travel on a passenger-mile basis.² Conventional rail transit is somewhat more energy efficient but is not well suited to the suburban development patterns prevalent in the United States and therefore is unlikely to account for much more than 1 percent of passenger travel in the future. To reduce high-carbon vehicle travel, policies must encourage better choices and more effective integration of land use, conventional mass transit, and transportation planning.

A new culture of innovation is needed in the

² Transit buses used far less energy per passenger-mile than autos 30 years ago, but the numbers have since flipped, as performance improvements and air conditioning were added, and ridership failed to keep pace with expanding bus service (2, Table 2.13).

In early 2008, Chevrolet began testing a fleet of more than 100 hydrogen-powered Equinox Fuel Cell vehicles in New York City, Washington, D.C., and Southern California. A communication cable from the refueling pump connects to an onboard computer that determines fuel temperature and pressure and how much hydrogen to dispense. The fuel cell adds about 500 pounds to the vehicle’s weight; aluminum doors and a carbon fiber hood compensate.



transport sector. Hints of change are emerging in the United States—for example, increased carsharing and bus rapid transit, a new law in California linking land use and vehicle miles traveled, and interest in conditioning transportation funds on environmental performance. The result could be a higher quality and less costly transportation system that consumes less energy and emits fewer amounts of greenhouse gases.

Moving Forward

The desire for personal mobility can be accommodated even while reducing the environmental and geopolitical impacts. Two overarching principles are suggested. First, develop consistent incentives to empower and motivate people and organizations. Second, advance a broad portfolio of energy-efficient, low-carbon technologies. This vision requires pervasive changes over a long period of time.

These transformations require leadership. The adoption of fuel economy and renewable fuel requirements in the Energy Independence and Security Act of 2007 was a positive step—although boosting corn ethanol may prove problematic.

Cues from California

Leadership may emerge at the local and state levels. For example, California is in the vanguard of climate and energy policy. A hotbed of environmentalism and entrepreneurialism, California adopted the world’s first air pollution regulations and monitoring systems and the first requirements to develop cleaner gasoline and zero-emission vehicles. Now it is leading with climate policy. If these initiatives are successful, California can lead America and the world away from petroleum and toward climate stabilization.

In fall 2006, the California legislature passed the Global Warming Solutions Act, which calls for reducing the state’s total greenhouse gas emissions to 1990 levels by 2020—roughly a 28 percent reduction from forecasted levels. A comprehensive set of rules and policies is being put in place as a follow-up to this law—including aggressive greenhouse gas emissions standards for vehicles, low-carbon fuel standards, and initiatives to reduce sprawl and reduce driving.

The vehicle standards would require an improvement of roughly 20 percent above the federal fuel economy standards adopted in December 2007. But the proposed California standards have become ensnared in legal battles over states’ rights.

California’s low-carbon fuel initiative may be even more instrumental in bringing about change. The standards require a 10 percent reduction in life-cycle greenhouse gas emissions from fuels by 2020 and



Advances in biofuels—including marketing and distribution—can produce key options for a transition to performance-based, low-carbon fuels.

provide a durable, performance-based framework for transitioning to low-carbon fuel alternatives. The California Air Resources Board is scheduled to adopt the standard in early 2009. Many other states are moving toward adopting California's fuel standards, as is the European Union.

The conversion of the national ethanol program into a performance-based, low-carbon fuel system would stimulate innovation in the entire range of alternative fuels—from biofuels to hydrogen—allowing industry to pick winners and to reduce carbon emissions from all options, including unconventional petroleum fuels.

The third thrust of the California program is to reduce vehicle travel. An enabling law was passed in September 2008 directing metropolitan regions to apply land use regulations and other means to reduce vehicle miles traveled. The law provides for funding to reward local governments, including adjustments to transportation funding.

If these new vehicle, fuel, and land use initiatives are successful, California can lead the United States and the world away from petroleum and toward climate stabilization.

National Policy Questions

The new Congress and president will debate energy security, climate policy, and transportation funding in the coming session. Will they embrace some of the policy innovations of California and others? Will they allow California and other states to proceed with more aggressive greenhouse gas standards for vehicles? Will they restructure and enhance the renewable fuels subsidies and mandates to be performance-based and to encompass promising alternative fuels? Will they reform transportation funding to empower state and local governments to reduce greenhouse gas emissions? Will local and state gov-

ernments reform their taxation rules and transportation financing practices to support innovative mobility services and more efficient land use and transportation patterns?

Hard Work Ahead

Human society faces a dilemma. People want cheap and easy mobility, and they want to travel in comfort and style. But giving free rein to these desires means more oil consumption and more greenhouse gas emissions; global tensions over scarce oil supplies and a rapidly altering climate; and potential devastation for many regions, many businesses, and many people. The challenge is to reconcile the tensions between private desires and the public interest.

America tends to embrace the desires of individuals in the name of freedom and consumer sovereignty and to place faith in technology and the marketplace to rescue society from its excesses. But how can the conflicts between private desires and the public interest be resolved?

Even according to the most conservative scenarios, dramatic reductions in oil use and carbon emissions are necessary. Sweeping transformations are in order and are slowly taking root. These transformations will only come about through an upsurge in innovation, entrepreneurship, and leadership.

Instead of bigger and more powerful vehicles, smarter vehicles are needed. Instead of demanding cheap oil, consumers need to embrace low-carbon alternatives. Government needs to invoke the public interest and spur new, cutting-edge enterprises. Leaders need to send consistent messages that encourage better choices. Instead of overlooking or decrying the growing demand for motorization in China, India, and elsewhere, global action is needed to encourage innovative solutions.

The transportation community needs to summon its ingenuity and take a big step forward. Intelligence, leadership, and a moral vision can transform the economy and society. Vehicles and fuels can be improved, new mobility options can be introduced, and unsustainable travel behaviors can be altered—and the planet eventually will be able to accommodate two billion cars.

References

1. Sperling, D., and D. Gordon. *Two Billion Cars: Driving Toward Sustainability*. Oxford University Press, 2009.
2. Davis, S., and S. Diegel. *Transportation Energy Data Book: Edition 26*. ORNL-6978, Oak Ridge National Laboratory, 2007.
3. Intergovernmental Panel on Climate Change. *Climate Change 2007: Mitigation of Climate Change*. In *IPCC Fourth Assessment Report, Working Group III Summary for Policymakers*, April 12, 2007.

Context-Sensitive and Sustainable Solutions for Transportation

Oregon's Bridge Delivery Program Model

THOMAS LAUER

The author is Manager, Major Projects Branch, Oregon Department of Transportation, Salem, and is a member of the Technical Committee on Preconstruction Engineering, American Association of State Highway and Transportation Officials.

When drivers motor along the highways and bridges of the nation's transportation network, they do not envision dollar signs. But the transportation infrastructure in many states is worth billions of dollars in materials and utility. Every day, Interstate 5 (I-5)—the main north-south corridor for the West Coast—carries more than 14,000 commercial vehicles through Oregon, bearing freight with a retail value of approximately \$650 million.

Oregon's highway bridges—like those in many other states—date from the 1950s and early 1960s, when the Interstate Highway System was established, and they have served well for their 50-year spans of design life. In 2001, regular bridge inspections by the Oregon Department of Transportation (DOT) revealed that the state's bridges were weakening, and that many required immediate weight restrictions, detours, and emergency repairs.

Investing in Transportation

An indication of the potential trouble occurred in March 2001, when Ford's Bridge on I-5 in southern Oregon was declared unsafe and in need of emergency repairs. For 20 days, the detour sent large volumes of traffic—especially trucks—through the small towns of Canyonville and Riddle, along streets that were not designed to bear large and heavy loads. The detour caused delays in travel times and disrupted the two communities. By 2003, Oregon DOT had placed weight restrictions on 140 bridges.

In response, the Oregon Legislature enacted the third Oregon Transportation Investment Act (OTIA III). Oregonians had not seen an investment of this magnitude in highway and bridge construction in 50 years. The OTIA funds are paying for the repair or replacement of hundreds of bridges, the paving and maintaining of city and county roads, the improvement and expansion of interchanges, the addition of

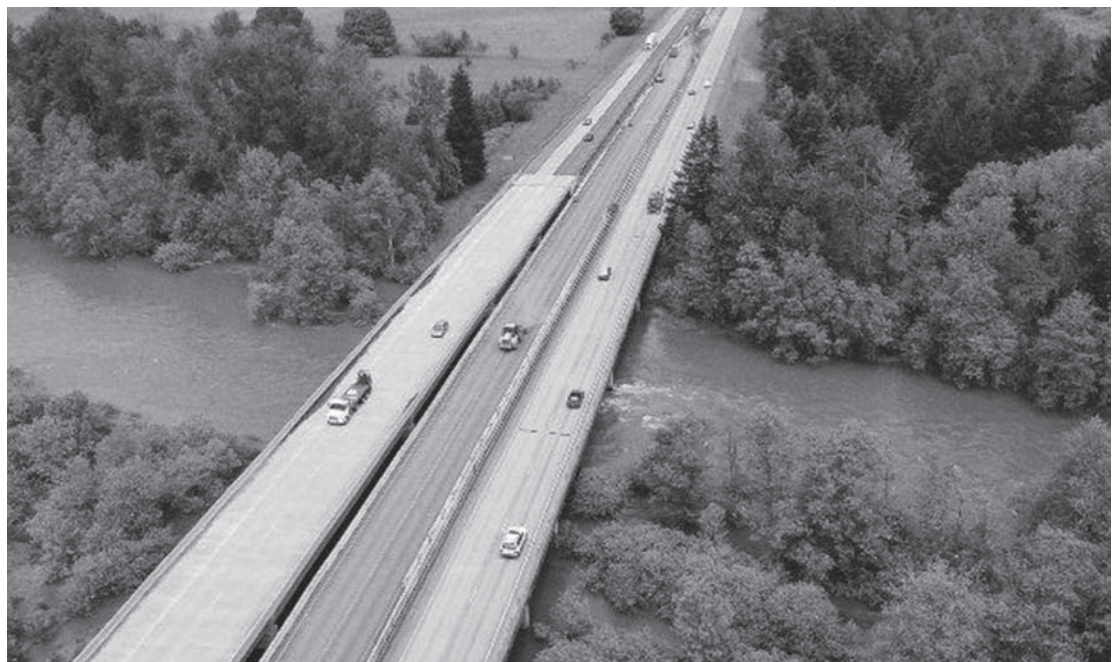

The Oregon Transportation Investment Act III funding package includes \$1.3 billion for the OTIA III State Bridge Delivery Program, a 10-year program to repair or replace bridges on the Oregon highway system; the Coast Fork Willamette River Bridge, south of Eugene, is a notable example.

new capacity to Oregon's highway system, and the removal of freight bottlenecks. The funding package includes \$1.3 billion for the 10-year OTIA III State Bridge Delivery Program, which is repairing or replacing bridges on the state highway system (see sidebar, at right).

Decision-Making Framework

The size and scope of the bridge program required Oregon DOT to change how it does business. If the agency had taken on the work, it would have had to expand massively for 10 years and then downsize dramatically. Instead, at the direction of the state legislature, Oregon DOT hired a private company, Oregon Bridge Delivery Partners, to assist in managing the program, and shifted from designing and constructing projects to managing the transportation system.

The agency also adopted a comprehensive framework for assessing projects and choosing solutions that best satisfied multiple goals and the maximum number of stakeholders. Context-Sensitive and Sustainable Solutions (CS³) is Oregon DOT's innovative decision-making framework, first implemented on the bridge program.

The precursor of CS³, Context-Sensitive Solutions (CSS), grew out of early work by the Federal Highway Administration (FHWA), the American Association of State Highway and Transportation Officials (AASHTO), and agencies in several states. These organizations established guiding principles for the National Highway System routes, integrating safety with environmental, scenic, historic, community, and preservation concerns.

In 2000, then-Governor John Kitzhaber issued an executive order on sustainability, directing all state agencies to take into account the needs of future generations in planning and in the use of resources. The bridge program presented an opportunity for Oregon DOT to integrate sustainability into CSS and to develop solutions that benefit the environment, communities, and project delivery.

CS³ helps the bridge program staff, contractors, and consultants work thoughtfully, economically, and collaboratively in a progressive way to deliver projects. The philosophy encompasses the processes, tools, and knowledge that keep Oregon DOT, architects, engineers, and contractors focused on the same approach and on agreed-to outcomes.

The criteria allow the agency to measure compliance and success in terms of the five goals of the bridge program:

- ◆ Stimulating Oregon's economy;
- ◆ Employing efficient and cost-effective delivery practices;

Oregon's Five-Stage Program for Bridge Repair and Replacement

Oregon DOT has scheduled the 10-year bridge repair and replacement work in five overlapping stages, to keep traffic moving with as little inconvenience to motorists as possible:

- ◆ The first stage, completed in October 2006, included repairs to bridges along the US-97 and US-26 corridor from Klamath Falls to Portland, and on US-20 from Bend to Ontario. These routes now serve as an alternate for commercial vehicles and motorists while repairs are under way on I-5 and I-84.

- ◆ Stage 2 is the largest stage, both in funding and in the number of bridges, including bridges on I-84 and the northern portion of I-5 from the Washington border to the Eugene-Springfield area.

- ◆ Stage 3 addresses bridges on southern I-5, from Eugene to the California border.

- ◆ Stage 4 repairs and replaces bridges on freight corridors connecting coastal communities to the Interstates, as well as on key north-south routes in eastern Oregon.

- ◆ Stage 5 encompasses routes and connections for rural and remote areas within eastern and central Oregon and the coastal corridor south of Coos Bay.



Workers install a guardrail along US-97 during the first stage of the Oregon bridge program.

- ◆ Maintaining freight mobility and keeping traffic moving;
- ◆ Building projects sensitive to communities and landscapes; and
- ◆ Capitalizing on funding opportunities.

Building Oregon's Economy

A primary legislative mandate and an Oregon DOT goal for the bridge program is to stimulate economic recovery by sustaining opportunities for jobs and contracts, from project development through the final bridge construction.

The scope and duration of the bridge program allow Oregon DOT to foster a more diverse, experienced workforce and to increase opportunities for small businesses that will remain assets for Oregon long after the bridge program is complete. Through a combination of outreach and compliance monitoring, Oregon DOT informs Oregon businesses and individuals proactively about work on the bridge program and monitors the awarding of contracts. The goal is not only to expand the diversity of participants but also to build the number of companies and to expand the pool of individuals to handle



Demolition of the Turner Road Bridge in Salem under a contract with Staton Companies, an Oregon-based and woman-owned company, which has secured bridge program contracts worth approximately \$1.46 million. Oregon DOT has worked to increase opportunities for minority- and women-owned companies.

heavy highway construction projects.

Six months before a project goes to bid, Oregon DOT notifies small businesses and certified firms about the opportunity to prepare competitive bids on a bridge program project in their area. Oregon DOT also issues 90-day and 30-day reminders.

By developing a range of contract sizes, Oregon DOT provides state contractors—including emerging small businesses and those owned by women and minorities—opportunities to compete more effectively with national firms (see sidebar, page 13). In 2007, 74 percent of bridge program spending went to Oregon firms.

Not only contractors but consultants are prospering from bridge program work. Oregon DOT is one of only a few programs nationwide that tracks the participation of design firms as well as of construction firms. Oregon DOT set a target of 15 percent for participation by disadvantaged, minority-owned, women-owned, and emerging small businesses in design contracting and wrote the target into the contracts. Bridge program staff prequalified 169 firms for prime contractors to draw on for specialty subcontracting. Of these, 33 are certified as disadvantaged, minority-owned, women-owned, and emerging small businesses—more than 19 percent.

As of May 2008, more than 75 percent of disadvantaged, minority-owned, women-owned, and emerging small businesses on the prequalified list had received work. In the first two years of the bridge program, these businesses received more than 40 percent of all design and program management contracts.

Skilled Workforce Development

The bridge program also benefits individual workers. Every \$1 million spent on transportation construc-

tion in Oregon sustains 14 family-wage jobs. Bridge program projects sustain an average of 2,300 jobs each year.

To expand the number of workers available for highway construction, the agency created a Workforce Development Program to increase diversity in employment, increase apprenticeship participation, and provide more training resources and opportunities for highway construction careers. The program taps into already functioning workforce development systems and resources to identify candidates—especially women and minorities—who are ready for skilled jobs in heavy highway construction projects. The program provides Oregonians with skills to maintain well-paying, sustainable careers.

Oregon DOT-led regional workforce alliances assess and train people for heavy highway construction jobs. Each regional alliance draws on local resources to implement programs.

Working with unions and other industry stakeholders, Oregon DOT set an initial goal of 5 percent for participation by apprentices in the bridge program workforce. In 2007, the bridge program achieved a 6.8 percent apprenticeship rate, with a total of 16,683 apprenticeship hours. The Workforce Development Program received the American Public Works Association's Diversity Exemplary Practices Award in 2007, for outstanding contributions to diversity.

In May 2008, Oregon DOT adopted a new method for sustaining trained, skilled workers in highway construction. The agency reimburses contractors on bridge program contracts for meeting or exceeding a project goal of 10 percent for apprenticeship and training but applies a disincentive if the goal is not met.



People interested in careers in heavy highway construction attend an apprenticeship orientation in Portland. In 2007, Oregon DOT achieved 6.8 percent apprenticeship participation in the bridge program, surpassing the agency's goal of 5 percent.

Oregon Contractor Success Stories

Building a Skilled, Diverse Workforce

Oregon DOT's bridge program has stimulated many local success stories for state-based contractors. One example is Knife River Corp., formerly Morse Brothers. Founded in 1941, the company has grown into a significant player in the Oregon construction community and has performed record-setting work on the bridge program.

Most notably, Knife River manufactured the first BT-90 precast concrete beams built in the state, for the Union Pacific Railroad overcrossing north of Chemult in southern Oregon. The dimensions of the seven record-setting beams were impressive—each was 183.75 feet long, weighed 179,000 pounds, and contained 1.6 miles of rebar.

In the midst of this project, Knife River hired approximately 70 new workers for its Harrisburg plant. The company's growth translates to greater revenue for businesses across the state. For example, Knife River buys rebar for girders from Farwest Steel Corporation in Eugene, which in turn buys ingots from Cascade Steel in McMinnville.

Capital Concrete Construction in Aumsville is another bridge program success story. Capital excavates, lays pipe, and pours concrete for projects along the Willamette Valley. The company recently replaced three bridges and repaired two others for the bridge program, completing a seven-month job in five months, helping Oregon DOT meet a schedule agreement with the City of Cottage Grove.

The project team had promised local stakeholders—city officials, state legislators, county commissioners, and business owners—that it would have the nearby London Road Bridge rebuilt and reopened for the summer travel season. But when utility work on the project fell seven weeks behind schedule, Capital agreed to put in overtime, brought in additional workers and equipment, and used higher-strength concrete to speed up the project. Capital's above-and-beyond approach is a quality that the agency seeks in a construction partner and has made the company a valued prime contractor.

To expand opportunities for Oregon companies, Oregon DOT prequalified approximately 120 specialty contractors for work on the bridge program. About half of those firms are owned by minorities or women.

For Big J, a minority-owned company in Medford, work for the bridge program became a springboard of opportunity. As a subcontractor to CH2M Hill, Big J secured two contracts,

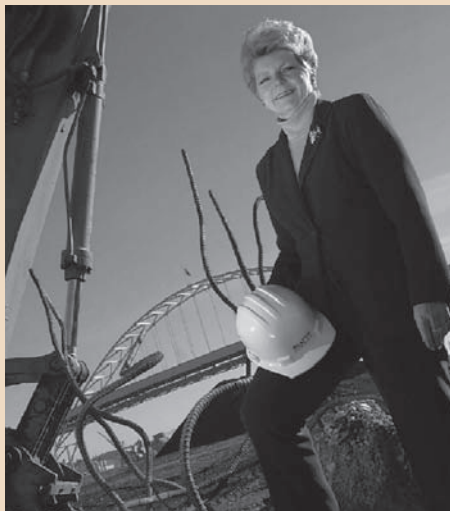

Contracts with the bridge program have allowed Jeanne Staton, owner of Staton Companies, to expand her business.

worth more than \$235,000, to install fencing along sections of I-5 from Roseburg to Sutherlin. As a result, Big J more than doubled its number of employees—adding an engineer, a field supervisor, an operator, and a laborer—and expanded its capacity to handle complex engineering and construction jobs.

Jeanne Staton started Staton Companies in 1971, and in the past two decades the company has become one of Oregon's leading bridge demolition contractors. Staton has contracts worth about \$1.46 million to dismantle sections of 28 aging bridges as part of the bridge program. For Staton Companies, the program's longevity is vital, enabling the purchase of expensive equipment and the hiring of additional employees.

Gearing up for bridge projects, Staton bought two \$300,000 Link-Belt excavators from Triad Machinery in Coburg and hired four additional full-time employees. The company is spreading bridge repair dollars around the state by renting special equipment, contracting with trucking companies, hiring concrete cutters, and leasing barges to work beneath bridges that span waterways.



Bridge program contractors install one of seven record-breaking precast concrete beams—manufactured in-state—at the Union Pacific Railroad overcrossing near Chemult, Oregon.



Oregon DOT worked with 11 state and federal regulatory agencies to create a more efficient system for environmental permitting; with the streamlined process, work on the bridge program's Coast Fork Willamette River Bridge project was finished in one season instead of two.

Planning for Efficiency

Planning enables responsible use of material resources as well as of staff time. Grouping or bundling bridge construction projects has maximized the participation by Oregon contractors, expedited the construction time, and produced economies of scale.

Alternative contracting methods—such as design-build—accelerate delivery while controlling costs. A single design-build contract permits design and construction work to overlap seamlessly. Design-build contractors have the latitude to propose creative solutions. For example, instead of building additional temporary structures for detours, an Oregon DOT contractor reused an entire bridge at several sites—a cost-effective and efficient use of resources made possible by the flexibility of the contract.

Streamlined Permits

The development of a single set of environmental performance standards is another compelling example of efficiency. Oregon DOT worked with 11 state and federal regulatory agencies to combine several regulatory requirements and environmental performance standards into a single set of permits for use throughout the program. The streamlined permitting process set environmental performance standards for the entire bridge program and has given contractors standardized, outcome-oriented goals.

Obtaining individual permits for the hundreds of bridges in the program—in a variety of ecosystems—

would have taken years. Oregon DOT streamlined the environmental permitting process without compromising the quality of the outcomes. The streamlining reduced both the cost of construction and a potentially overwhelming workload for state and federal agencies.

On the Coast Fork Willamette River Bridge project, for example, the agency shaved more than 90 days from the usual process with the new programmatic permits. The expedited permitting process allowed bridge construction to be completed in one season instead of two, because the contractor could avoid a second hiatus during the fish spawning and migration season, when work in a river is prohibited.

The new process not only is cost-effective and efficient but also protects and conserves natural resources. On the Coast Fork Willamette River Bridge project, the shortened construction period yielded environmental benefits—the river is a habitat for Oregon chub fish, an endangered species found only in Oregon's Willamette Valley.

With the expedited procedures, permits are granted efficiently, and compliance has increased. For the third year in a row, no permit violations have occurred, and no endangered fish species have been harmed or killed.

To date, 141 bridges have received permits under the streamlined process and another 72 have initiated permits or are under review; only 10 bridges have had to use a different procedure. This success and efficiency have earned the bridge program several recognitions: a 2004 Environmental Excellence Award from FHWA; a 2004 Environmental Stewardship Excellence Award from U.S. Fish and Wildlife Service; and a 2005 Best Program Award for Environmental Excellence from AASHTO.

Traffic Management Tool

In addition, Oregon DOT developed traffic management plans at the corridor level to preempt delays on I-5 and I-84, whenever possible. Traffic engineers anticipate delays by making two calculations: first, to determine when the average volume of traffic would be low enough for a contractor to close a lane and complete work; and second, to project the length of time that drivers might expect to be delayed on a given segment of highway. Completing this analysis, however, required two to four hours.

To speed up the analysis, bridge program traffic engineers adapted a spreadsheet that was developed to automate the retrieval of historical data. The new spreadsheet, the Work Zone Traffic Analysis program, completes the delay calculations in less than one minute. The program is web-based, so that Oregon DOT personnel can update and modify the data con-

A shortened construction period minimized disturbances to the Willamette River habitat of the Oregon chub fish, an endangered species found only in the state's Willamette Valley.



tinually and use the program for all aspects of highway work, including construction, utility work on rights of way, surveying, and routine maintenance.

The bridge program's mobility team received an award for the analysis tool from AASHTO's Standing Committee on Quality in 2007. The Team Excellence Award acknowledged the group as a "pathfinder in quality team achievement."

Improving Outcomes

The bridge program holds to Oregon DOT's goal of producing the best possible outcomes for people, species, and habitats while maintaining a safe and efficient transportation system.

Most bridges span bodies of water, making waterways an ongoing focus of the bridge program's environmental stewardship. The design teams work to limit a bridge's impact on the natural environment. For example, precast concrete beams allow single-span structures, which eliminate footings in streams and enhance the habitat.

To date, less than 20 percent of the projects have affected rivers, streams, or other wetlands. In addition, Oregon DOT has cleared away more than 4,200 cubic yards of fill from waterways, to help develop floodplains and free-flowing rivers and streams for optimal habitats. In working on bridges, Oregon DOT also has introduced enhancements whenever possible—for example, by removing pilings that destroy fish habitats or enlarging banks to protect the course of a river or stream.

In the coming year, in response to feedback from regulatory agencies, Oregon DOT will continue to



make the programmatic permit applications as concise and user friendly as possible. The department continually refines tools and templates to streamline other processes, such as biological assessments, environmental baseline reports, preconstruction assessments, and wetland delineation reports.

Recycling Materials

Oregon DOT monitors construction waste, equipment emissions, materials selection, and the life cycle and durability of the bridges. By incorporating the concrete from an I-5 demolition into aggregate for another project, Oregon DOT saved approximately \$360,000. In 2008, the American Road and Trans-

Oregon DOT's Work Zone Traffic Analysis program helps traffic engineers make delay calculations in less than one minute, to keep motorists moving across Oregon. Originally a stand-alone application, the program is now web-based, allowing other Oregon DOT employees to update and modify data.



Waterways are a major environmental focus for the bridge program; single-span structures eliminate footings in streams and rivers, allowing Oregon DOT to minimize the impact of a bridge on the environment.



After completion of the Coast Fork Willamette River Bridge project, Oregon DOT reused 80 of the 88 beams of the detour bridge on three other bridge program projects.

portation Builders Association awarded Oregon DOT a Globe Award for this project, recognizing the agency's recycling and environmental protection efforts.

Recycling is one of the most visible aspects of the bridge program's efforts to decrease environmental impacts. In replacing two bridges on I-5 near Wilsonville and repaving 22 miles of six-lane highway, more than 130,000 tons of pavement were recycled at an asphalt processing facility, keeping the materials out of landfills.

On another project, 88 beams from a detour bridge were no longer needed. Instead of hauling the beams away as scrap, Oregon DOT reused 80 for other detour bridges. On the same project, approximately 30,000 cubic yards of demolition rubble were recycled into embankment material on a nearby bridge project and for the widening of the Springfield-Creswell Highway and I-5 interchange.

Public Involvement

Well before any heavy equipment or construction crews arrive on site, Oregon DOT and its public involvement teams research the effects on the local community. The research yields a list of community members, government representatives, and other

stakeholders whom Oregon DOT updates throughout the project.

After creating the stakeholder list, Oregon DOT develops a plan to engage and involve members of the community. Public involvement teams use a variety of techniques, from mailings and news releases to one-on-one meetings and public events, to notify the community that the bridge project is under way.

Early in the design process, Oregon DOT sends out engineers, project managers, and public involvement teams to gain input from the local community. At open houses, town hall meetings, and school events, the teams display preliminary drawings and answer questions. Personal conversations and comment forms have proved effective for feedback.

The public involvement team compiles the comments and provides the information to engineers, mobility planners, and construction contractors. The public still can provide input by e-mail or by calling the public involvement representative or public information officer (see sidebar, page 17).

Other strategies for keeping community members up to date about construction projects and for soliciting input are earning industry approval. Oregon DOT won two awards from the Portland Chapter of the Public Relations Society of America—a Spotlight Award in the editorial-opinion category for a webcast with Oregon DOT Director Matt Garrett during the 2007 construction season and a Merit Award for the "Building Bridges and Public Support" campaign.

Leveraging Outside Funding

Although the primary financing for the bridge program is revenue from increased motor vehicle and trucking fees, Oregon DOT capitalizes on other sources of funding whenever possible. The department secured \$1.8 million in federal allocations over two years to fund a workforce development program. In conjunction with the Lane County Regional Air Pollution Authority, Oregon DOT applied for grants to provide subsidies for clean-burning fuel and to retrofit the engines of the construction equipment to burn the new fuel. Oregon DOT also secured a \$1 million Highways for LIFE grant from FHWA for "innovative approaches to building highways safer, longer-lasting, faster, and at a lower cost," to be applied to rapid replacement techniques on two bridges in Elkton.

Crowning Project

As the bridge program marks the halfway point of its 10-year span, Oregon DOT is beginning the single largest project in the program, the replacement of the Willamette River Bridge. Built in 1962, the bridge spans Oregon's primary north-south river and



Oregon DOT saved money by recycling the concrete from an I-5 demolition into aggregate for another project.

Public Involvement Shapes Scenic Corridor Project

Intensive public involvement during the design phase was critical for a project in the historic Columbia River Gorge National Scenic Area along I-84. Winding along the banks of the Columbia and skirting the shadow of Mount Hood, the Interstate serves as Oregon's east-west transportation lifeline, accommodating commerce and tourists. The corridor includes 17 bridges slated for repair or replacement. Each offers a vantage point for observing the beauty of the Gorge and also provides a critical economic link for local communities.

Before design began for the Gorge project, Oregon DOT worked closely with community members, stakeholders, and representatives of state and federal agencies to gather input and secure buy-in on design elements ranging from abutments and railings to landscaping and wildlife crossings. The resulting I-84 Corridor Strategy provides a framework of design guidelines to help Oregon DOT manage and improve the Interstate in ways that meet public safety and transportation needs, as well as National Scenic Area requirements.

The I-84 Corridor Strategy generated national attention.



On I-84, the major highway that runs through the Columbia River Gorge National Scenic Area, 17 bridges are slated for repair or replacement.

The American Council of Engineering Companies recognized Oregon DOT and its partners with the 2007 Engineering Excellence National Recognition Award for the design guidelines.

stretches almost one-third of a mile. The bridge is no longer structurally sound enough to support the heavier freight and the increased traffic of the 21st century and needs to be replaced with a stronger, more substantial structure. The new bridge will cost approximately \$180 million, with funding coming from two sources—the federal Safe, Accountable, Flexible, Efficient Transportation Equity Act: A Legacy for Users and OTIA III.

The project is prominent for its large contract value and for the bridge's structural girth and key location. In addition, the bridge project affects a variety of people and creatures—bikers, hikers, boaters, travelers, truck drivers, and train engineers, as well as animals, fish, plants, and their habitats—making the design and construction a challenge.

To deal with these complexities, Oregon DOT is applying a little-known but highly effective construction technique, construction manager-general contractor, or CM-GC. With this approach, the agency, the bridge designer, and the bridge builder work closely together from the start. Oregon DOT will incorporate information from public involvement and stakeholder meetings quickly into the bridge's design and construction.

Innovation, Adaptation, and Agility

Without bridge program funding, weight limits would have become common on Oregon's aging

bridges. In the next 25 years, this would have cost the state an estimated \$123 billion in lost production and 88,000 lost jobs. By proactively updating its bridge infrastructure, Oregon stands ready to handle the wider, heavier vehicles that are traveling faster in vital transportation corridors. In addition, in making the adaptations, Oregon DOT has become a more innovative and agile agency, ready to manage the challenges of the new century.

Stretching for almost one-third of a mile, the Willamette River Bridge is the single largest project in the bridge program. Construction is scheduled for completion in December 2012.



Creating a Culture of Traffic Safety

Learning from Four States with Improved Safety Records

BETTY J. MERCER

The author is President, Mercer Consulting Group LLC, East Lansing, Michigan. She was Michigan's State Highway Safety Office Administrator for 10 years. She chairs the TRB Occupant Protection Committee.

A crash on a major mid-Atlantic Interstate underscores the daily dangers on U.S. roadways. Some states have taken concerted measures to develop and adopt a culture of highway safety and have stemmed and even trimmed the rate of crashes.

The rate of traffic-related fatalities is increasing nationwide, yet some states are achieving continual improvements in highway safety. These states have found a winning combination of strategies and have identified methods that can be implemented effectively.

The states that have achieved this success share a key characteristic—a consistent impetus to develop a statewide traffic safety culture. Discovering how these states have established a successful safety culture could be useful to other states determined to make similar strides in safety.

In 2006, the Federal Highway Administration (FHWA) and the National Cooperative Highway Research Program (NCHRP), in cooperation with the American Association of State Highway and Transportation Officials (AASHTO), sponsored case studies to identify and document the organizational elements that support successful state programs and strategies to reduce highway fatalities and serious injuries.

Case Studies' Focus

The case studies examined the technical and institutional initiatives implemented by the state departments of transportation (DOTs) and state highway safety offices (SHSOs) in Iowa, Michigan, Minnesota, and Washington.¹ These initiatives produced a culture of safety in each state. The four states were selected because of their success in reducing fatalities and serious injuries for an extended period of time. Three of the states—Iowa, Michigan, and Washington—received the first AASHTO-sponsored Safety Leadership Award in 2005.

The case studies covered the past 30 years of each state's safety record and focused on key milestones, individuals, and agencies. The major factors examined were organizational leadership, political leadership, and the processes to institutionalize safety. The champions of safety and the actions that led to immediate gains and to sustained, long-term safety achievements were highlighted.

The case study for each state was published in a separate report. A PowerPoint presentation describing the themes common to all four states is available from NCHRP.¹

The primary focus of the case studies was the role of the state DOT and the SHSO in supporting a traffic safety culture. Interviews were conducted in each state with the governor's highway safety representative or SHSO director, the DOT safety engineer and planner, and representatives from FHWA, the National Highway Traffic Safety Administration (NHTSA), metropolitan planning organizations (MPOs), and local agencies. Although other state and local traffic safety partners made significant contributions to the state safety programs, time constraints did not permit individual interviews; their often significant contributions, therefore, receive only general reference.

¹ For copies of the case studies and the PowerPoint presentation, send an e-mail to Chuck Niessner, Senior Program Officer, NCHRP, cnliessner@nas.edu.



TABLE 1 Overview of Case Study Statistics

State	Population	Registered Drivers	Registered Vehicles	Roadway Miles	State Roads	Local Roads	VMT Billions	Fatality Rate ^a	% Alcohol Related	% Seat Belt Use ^b
Iowa	2,944,062	2,100,000	3,994,669	113,838	8%	92%	31.5	1.39 ^c	38	89.6
Michigan	10,120,000	7,040,000	9,300,000	122,000	8%	92%	103.2	1.09	37	94.3
Minnesota	5,210,000	3,873,093	6,297,479	135,000	9%	91%	56.5	.09 ^b	35	83.3
Washington	6,265,400	4,725,224	5,724,912	83,380	8%	92%	55.5	1.17	45	96.3

VMT = vehicle miles traveled. ^a Per million VMT. ^b 2006 data. ^c 2006 preliminary data.

Major Findings

In recent years, each of the four states had experienced decreases in traffic-related fatalities, fatality rates, and alcohol-related fatalities. Most had achieved record levels of seat belt use in comparison either with their own previous statistics or with the national average.

The four states represented a range of population sizes and annual vehicle-miles traveled (Table 1) and had similar proportions of state and local road ownership (Figure 1). Each state set a high standard for safety.

The case studies revealed the following major findings:

- ◆ All four states achieved goals that surpassed the national record.
- ◆ Iowa, Michigan, and Washington achieved consistent gains over an extended period of time.
- ◆ Minnesota's success was more recent but was impressive.
- ◆ Each state had developed a cooperative, coordinated, collaborative program with a statewide reach.
- ◆ Individual leaders emerged to champion the safety program in each state.

Leadership Contributions

In the area of organizational leadership, the following common factors were found: key individuals with a passion for improving traffic safety; a strong partnership between the state DOT and the SHSO; the removal of barriers between agencies; adequate technical and funding resources dedicated to local road improvements; and accountability in achieving results.

Another major factor, political leadership, revealed strong interest and support from influential state leaders and from the governor; the sponsorship of strategic legislation through the concerted efforts of champions; the enactment of critical traffic safety laws by the state legislatures; the provision of necessary funds to support safety; and promotional campaigns to gain support for safety programs among the general public (see

theme graphic from the Iowa campaign, page 20).

Legislatively, each of the states emphasized the enactment of key safety laws. Nonetheless, each state safety program would have achieved success even if the full complement of laws had not passed.

Institutional Processes

The four states institutionalized processes with several common characteristics:

- ◆ Highly developed data collection and analysis systems;
- ◆ A statewide, systematic approach to improve all state and local roads;

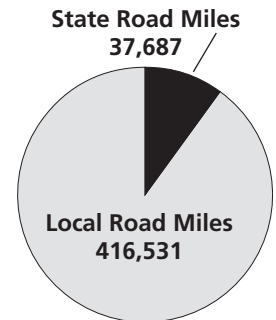
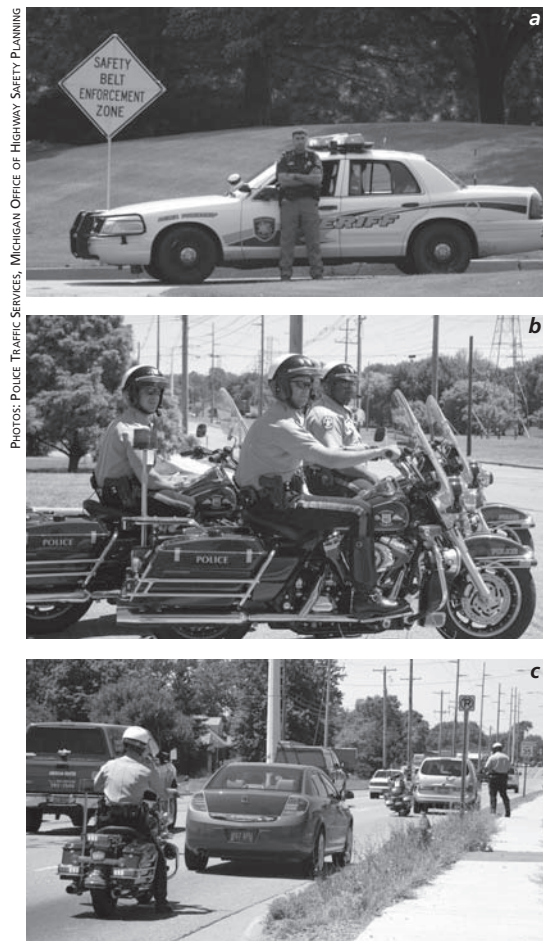

FIGURE 1 Proportion of state versus local road miles in the four case study states.



One of the case study states, Michigan, does not conduct safety belt checkpoints but designates enforcement zones—areas of roadway marked with large yellow signs. In the zone, (a) one officer serves as a spotter for safety belt use and will radio information about noncompliant drivers or passengers (b) to nearby officers on motorcycles or in patrol cars; (c) the officers then pull over the offending motorist.



Theme graphic from Iowa Safety Management System's public information campaign quickly delivers an effective, sobering message.

Building and maintaining a road safety culture faces challenges not only in application—for example, on I-5 near Tacoma, Washington, in inclement weather—but in funding, leadership, legislative impetus, media interest, communication, and more.



- ◆ Use of the AASHTO model for strategic highway safety plan development²;
- ◆ Partnerships with federal, state, and local agencies to plan and implement behavioral and engineering programs; and
- ◆ Statewide application of national programs to prevent impaired driving and to increase seat belt use.

The states achieved these institutional successes through a safety infrastructure that was formally or informally charged with providing safety leadership statewide. The systems were similar to those envisioned for the Safety Management System formerly mandated under the federal Intermodal Surface Transportation Efficiency Act of 1991. Each state formed a broad-based collaborative partnership to encourage state and local leaders who have responsibilities for traffic safety to work together and coordinate activities.

Strategies for Success

Despite the varied structures and support systems in the four states, common strategies for success were implemented—such as the following:

- ◆ Aggressive goal setting;
- ◆ Prioritized engineering strategies;
- ◆ Comprehensive behavioral programs;
- ◆ Advanced data collection and analysis systems;
- ◆ Reliance on data-driven planning and programming; and
- ◆ Establishment of a broad base of partnerships.

The case study reports detail specific examples of the strategies implemented in each of the states.

FHWA and NHTSA, the federal safety agencies assigned to provide oversight and support to SHSOs and state DOTs, were valuable partners in each of the four states. FHWA and NHTSA personnel at all levels encouraged the adoption of behavioral and local engineering best practices and solutions, providing technical resources and available federal funding.

The federal agencies also assisted with data and research to support legislative initiatives; regional support for

² <http://safety.transportation.org/plan.aspx>.

state highway safety planning; coordination and communications support to mobilize national programs for seat belt use and the prevention of impaired driving; proactive encouragement to develop and implement low-cost state and local safety improvements; collaboration fostered through the Safety-Conscious Planning initiative and through the Strategic Highway Safety Plan requirement; and the provision of technical resources through training, research material, safety publications, and peer-to-peer exchanges.

Ongoing Challenges

Although the case study states have developed strong programs at the state and local levels, the agencies face continual challenges to maintain a high level of focus on improving traffic safety. The most frequently cited potential threats to the continuing success of the state traffic safety programs were funding reductions; requirements to address additional crash characteristics; weakening of the legislative culture; the potential loss of safety champions; the continuing challenge to maintain media interest; changes in the typical methods of communicating with the public—for example, via the Internet; and citizen complacency.

To address these challenges, the states commonly identified the need to continue the Strategic Highway Safety Plan process, to implement their plan in full, and to engage partners to achieve safety goals. Similarly, the states are targeting data-driven, research-based strategies, to advocate for safety support at the highest government and political levels, to enhance data collection and analysis systems through new technology, to maximize funding to support safety initiatives, and to renew efforts to enact and retain key traffic safety laws.

Practical Models

The target audiences for the case studies are leaders at the middle and higher levels in the transportation safety community, including the DOT safety engineers and SHSO directors who implement the state Strategic Highway Safety Plans. These lessons learned can provide other states with useful information and guidance for enhancing their safety programs.

The case studies of the four states offer practical models for other states that are interested in examining and developing their safety culture. The studies assemble a variety of approaches and strategies—states can combine and apply solutions that offer the greatest potential for moving toward the successful achievement of their safety goals.

The Role of Transit in Emergency Evacuation

NANCY HUMPHREY

The author is Senior Staff Officer, TRB Division of Studies and Special Programs, and served as Study Director for this project.

Transit can play a vital role in an emergency evacuation. After terrorists attacked on September 11, 2001, transit quickly shuttled passengers out of Lower Manhattan and rushed employees, buses, and equipment to the World Trade Center site to support emergency responders.

In 2005, transit could have played an important role in evacuating New Orleans in advance of Hurricane Katrina but failed to do so when few drivers reported to work, transit equipment proved inadequate and was left unprotected, and communications and incident control were nonexistent. Emergency plans that inadequately represent transit

or that are poorly executed risk significant loss of life, particularly among those who depend on transit for evacuation from harm's way.

Study Charge and Scope

Transportation Research Board (TRB) Special Report 294, *The Role of Transit in Emergency Evacuation*, explores the roles that transit systems can play in accommodating the evacuation, egress, and ingress of people to or from critical locations in an emergency. The study was requested by Congress, funded by the Federal Transit Administration (FTA) and the Transit Cooperative Research Program, and conducted by a committee of experts appointed by the



People in Manhattan's Battery Park await evacuation by ferries and buses after the September 11, 2001, terrorist attacks on the World Trade Center.



PHOTO: TIM JOHNSON, REUTERS

Paratransit vehicles prepare for an evacuation before a hurricane.

National Research Council of the National Academies under the auspices of TRB (see box, page 23). The study focuses on transit systems in the nation's 38 largest urbanized areas—a proxy for transit properties serving more than 1 million people.

The study defines transit broadly, including bus and rail systems, paratransit and demand-responsive transit, commuter and intercity rail, and ferries, whether publicly operated or privately contracted. Highways and their capacity also are considered, because many transit systems provide bus service only and must share the highways with private vehicles in an emergency evacuation.

The report focuses on major incidents that could necessitate a partial to full evacuation of the central business district or other large portion of an urban area. Meeting the surge requirements and coordination demands for such incidents is likely to strain the capacity of any single jurisdiction or transit agency and to exceed local resources.

Planning for Evacuation

Historical data show that severe storms are the most common major, presidentially declared disaster. U.S. regions, however, face different hazards—for example, hurricanes along the Gulf and Atlantic Coasts, flooding in the Midwest, and earthquakes in California and elsewhere. Some hazards, like tropical storms, recur with regularity and are known in advance. Others, like earthquakes and terrorist events, strike without warning.

Communities can plan for the former, but planning for the latter is difficult. Because of the general unpredictability of many hazards and the uncertainty about the precise location of an incident and the extent of its impact, emergency managers and public safety planners take an all-hazards approach to planning and scale the response to the type and magnitude of the disaster.

Local governments are primarily responsible for handling emergency incidents and for ordering an evacuation. If an incident overwhelms local capability, mutual aid agreements with neighboring jurisdictions can be invoked. In a major event or when special equipment is needed—for example, U.S. Coast Guard vessels or helicopters—state and federal assistance may be requested.

Typically, transportation and transit agencies play a supporting role in an emergency incident. Local emergency managers coordinate the response. Police, fire, and emergency medical services—the first responders to an incident—generally take the lead in an evacuation.

Transit's ability to be a successful partner in an evacuation depends on a good local emergency response and evacuation plan. These plans generally comprise four major elements: mitigation, preparedness, response, and recovery.

Transit has a role in each of these areas. The extent of transit's participation and the capability of the local area to plan for and respond to an emergency, however, depend on the type of emergency involved; the characteristics of the urban area; the geographic considerations—particularly constraints, such as limited access to a mainland location; the number of jurisdictions that must coordinate in an emergency; the willingness of citizens to heed evacuation orders; the resources; and more.

Incorporating Transit

The emergency operations plans for most urbanized areas do not describe in specific and measurable terms how to conduct a major evacuation successfully, and few plans include a role for transit. Local emergency managers therefore should increase their attention to evacuation planning as an important element in emergency planning; moreover, they should determine and incorporate a role for transit and other public transportation providers in meeting evacuation needs. Yet ensuring that transit is included in evacuation plans is the responsibility not only of emergency managers but of transportation and transit agencies.

Among the localities with evacuation plans, few have provided for a major disaster involving multiple jurisdictions or multiple states in a region and necessitating an evacuation of a large portion of the population. Leadership is lacking because the problem is not specific to any one jurisdiction, and no clear regional emergency management protocols are evident. Moreover, the feasibility of evacuating major portions of large, highly developed, congested urban areas is questionable. In many urban areas, severe congestion at peak periods lasts for several hours

each morning and evening, straining the system under normal conditions.

To help fill the planning gap, the report recommends that the Department of Homeland Security and the Federal Emergency Management Agency, in conjunction with the U.S. Department of Transportation, provide guidance to state and local governments on regional evacuation planning, including the role of transit and other public transportation providers, and that states should take the lead in ensuring the development of these plans, in coordination with appropriate regional entities.

In addition, federal funding should be provided for the development of regional evacuation plans that include transit and other public transportation providers. The grant recipients should be required to report on their progress and to meet milestones and timetables.

Transit as a Full Partner

Where local emergency evacuation plans have included transit as a full partner, the transit agencies have been involved in the development of the plans and are part of the designated emergency command structure. The committee therefore recommends that transit agencies participate with emergency management agencies and departments of transportation in developing evacuation plans and be full partners in the command structure established to handle emergency response and evacuation.

Transit agencies that are recognized as full partners in emergency evacuation plans will have to take on new responsibilities and costs—they should be eligible therefore with other first responders for cost reimbursement. Transit agencies should be considered essential personnel, along with police, fire, and emergency medical services, when they are asked to take on a major role in an emergency evacuation.

For transit to be used to its maximum potential, the emergency operations centers of transit agencies should be linked to those of emergency management agencies. Transit should have the capability for real-time, interoperable communications via voice and data, be part of the decision-making team for emergency operations, develop effective ways of communicating with transit passengers before and during an emergency, and participate in annual exercises and drills involving multiple agencies and jurisdictions.

Transit's Roles

Transit can perform multiple roles in an emergency evacuation. For example, it can transport those who do not have access to a private vehicle, either to area shelters or to other destinations. Transit is often the only means of evacuation for vulnerable, carless pop-

ulations, many of whom may need assistance. Transit drivers also can transport emergency personnel and equipment to an incident site. After the emergency has passed, transit providers can transport carless evacuees to their original locations or other destinations, help supply real-time information on the extent of damage, and resume normal service as quickly as possible.

Emergency managers, elected officials, and the general public should be realistic in their expectations about the role of transit in an emergency evacuation, particularly in a no-notice incident that occurs during a peak service period. Transit's participation depends on the nature of the incident and its location in a region; the size and scale of area transit service; and the extent of damage—if any—to transit equipment and facilities.

Meeting surge requirements also will depend on the availability of transit drivers and equipment, a particular challenge at off-peak times; contractual requirements for continuity of service by contracted transit providers; and mutual-aid agreements with other providers to fill service gaps. A major no-notice emergency occurring at a peak period, when transportation systems are heavily congested, would severely tax the capacity of the system, including transit.

Target Populations

Transit has a unique role in evacuating the carless and special-needs populations—such as the disabled, the elderly, and the medically homebound—in an emergency, but most local emergency evacuation plans do not address the needs of these groups

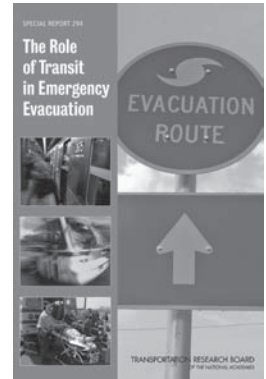

TRB Special Report 294, *The Role of Transit in Emergency Evacuation*, is available from the TRB online bookstore, www.trb.org/bookstore; to view the book online, go to <http://onlinepubs.trb.org/onlinepubs/sr/sr294.pdf>. Also available on the web is a supplemental table that provides detailed responses to an online assessment of transit's role in the emergency response and evacuation plans of 33 urbanized areas and related states—http://onlinepubs.trb.org/onlinepubs/sr/sr294_appendixC.pdf.

Committee on the Role of Public Transportation in Emergency Evacuation

Richard A. White, DMJM Harris, Arlington, Virginia, *Chair*

Evelyn Blumenberg, University of California, Los Angeles

Kenneth A. Brown, New York City Transit

John M. Contestabile, Maryland Department of Transportation, Hanover

Ali Haghani, University of Maryland, College Park

Arnold M. Howitt, John F. Kennedy School of Government, Cambridge, Massachusetts

Thomas C. Lambert, Metropolitan Transit Authority of Harris County, Houston, Texas

Betty Hearn Morrow, SocResearch Miami, Florida

Michael H. Setzer, Veolia Transportation, Cincinnati, Ohio

Ellis M. Stanley, Sr., Dewberry LLC, Los Angeles, California

Andrew Velásquez III, Illinois Emergency Management Agency, Springfield



Transit has a unique role in evacuating special-needs populations; developing methods for identifying, locating, and communicating with these individuals is an important area for research.

adequately. Part of the difficulty is the diversity of population groups involved and the different types of transit services required. For example, ambulatory but carless low-income populations can use fixed-route transit service, but the elderly, disabled, or medically homebound are likely to require para-transit service with accessible equipment and trained operators.

In addition, identifying the geographic location and transit needs of special needs populations and keeping the information up to date are major challenges. Evacuation of the carless and those with special needs therefore must be a major concern in evacuation planning, operations, and funding. A public information campaign and sheltering strategy should be developed to target these populations specifically.

Capacity Enhancements

The capacity and resilience of transit and highway systems affect the successful use of transit in an emergency evacuation, but funding programs do not address these needs directly. In the reauthorization of the Safe, Accountable, Flexible, Efficient Transportation Equity Act: A Legacy for Users, Congress should authorize FTA and the Federal Highway Administration to fund evacuation-related capacity enhancement projects that add redundancy to critical transit and highway infrastructure. In addition, funding should be increased for intelligent transportation systems technologies that can enhance net-

work resilience in an emergency. State funds also should be directed to these purposes.

Needed Research

Research is needed to support many of the committee's recommendations. Network simulation models, developed and used by several metropolitan planning organizations to model evacuation times and road capacity, should be extended to include transit buses in the traffic projections. Models should be developed for use in additional urban areas.

Research also is needed to improve understanding of the spatial dimensions of the demand and supply of transit services in an evacuation. Projects could include effective ways to identify general and special-needs populations who are likely to use transit in an emergency evacuation; the best methods for communicating with these groups before and during an event; methods for assessing the availability and for inventorying the allocation of transit equipment and drivers; best practices to ensure the availability of the transit workforce through family evacuation assistance programs; and ways to mobilize the private sector—for example, with rental cars and private bus fleets—in an emergency.

Responsibility for Planning

Enhancing transit's role in emergency evacuation depends on the actions of many. Most of the recommendations in *The Role of Transit in Emergency Evacuation* require the joint action of local emergency managers and transit agencies.

State emergency management agencies, state departments of transportation, and state departments of health, however, have critical roles to play in coordinating the development and implementation of regional evacuation plans, funding and managing operational improvements on major evacuation routes, and sheltering special-needs populations. Social service agencies and nonprofit organizations are important partners in helping special-needs groups.

Finally, federal agencies and Congress can supply guidance to state and local governments in developing regional evacuation plans that include roles for transit and other public transportation providers and in allocating the funds to help carry out the plans. In addition, evacuation-related capacity enhancement projects that will add redundancy at critical links in transit and highway systems should be a priority, along with intelligent transportation systems projects to enhance network resilience.

A concerted local, state, and federal effort can realize the full potential of transit in emergency evacuation.



Fighting Fatigue in Steel Bridges

Kansas Bridge Design Engineers Guide Research Solutions into Practice

JOHN PATRICK JONES, CAROLINE BENNETT, ADOLFO MATAMOROS, STAN ROLFE, AND KIM RODDIS

Jones is Bridge Design Manual Engineer, Kansas Department of Transportation, Topeka; Bennett is Assistant Professor, Matamoros is Associate Professor, and Rolfe is the A. P. Learned Distinguished Professor, Department of Civil, Environmental, and Architectural Engineering, University of Kansas, Lawrence; and Roddis is Chair, Civil and Environmental Engineering Department, George Washington University, Washington, D.C.

Accumulated fatigue damage in steel bridges presents a particularly insidious challenge to bridge designers and engineers. Because the effects of fatigue are difficult to quantify before identifiable cracks occur, bridge engineers try to design bridges with infinite fatigue lives. Many details that were considered good practice three decades ago, however, have proved detrimental to the fatigue performance of steel bridges.

Distortion-induced fatigue is one of the most difficult fatigue-related problems to address. The phenomenon occurs when adjacent girders at the same cross-section of a bridge undergo different deflections. Because of the difference in the deflections, the brace elements induce out-of-plane deformations and stresses on the girders they connect.

The effect of these stresses on the bridge's fatigue life is difficult to quantify and was not a consideration in bridge design practice three decades ago. The use of connection details that are prone to fatigue cracking in the vulnerable girder web-gap region (see Figure 1a), therefore, was widespread.

Different approaches have been developed to repair girders that are vulnerable to distortion-induced fatigue. One method is to modify the connection

between brace elements and the girder so that distortion occurs over a relatively long segment of the web, reducing the stress demand in the area that is prone to fatigue cracking. A second repair method takes the opposite approach and modifies the connection to engage the girder flange directly, avoiding the load path through the vulnerable web-gap region.

Choosing the wrong technique, however, can accelerate bridge damage. Because choosing the repair method that is best suited to an individual bridge is difficult, tailored research studies often are necessary to identify the appropriate repair technique.

The Kansas State Bridge Office (KSBO) employs a bridge management approach similar to that used by other agencies—bridges are inspected at regular intervals, and repairs and replacements are prioritized by the availability of resources and the level of need. Whether or not a bridge is to be replaced depends on the level of deterioration and on the level of use by the traveling public.

K-TRANS, a research program sponsored by the Kansas Department of Transportation (DOT), undertakes research projects to address challenges faced by agency engineers. Many of the program's research projects have contributed to the KSBO's bridge

management activities. The KSBO identifies the challenges, and universities are encouraged to submit proposals to K-TRANS to develop solutions.

Two steel bridges experienced distortion-induced fatigue cracking and were repaired successfully by applying results from K-TRANS research. The case studies follow. The success of the repairs has saved Kansas DOT millions of dollars in bridge replacement costs and has provided proven retrofit techniques that can be applied in the future.

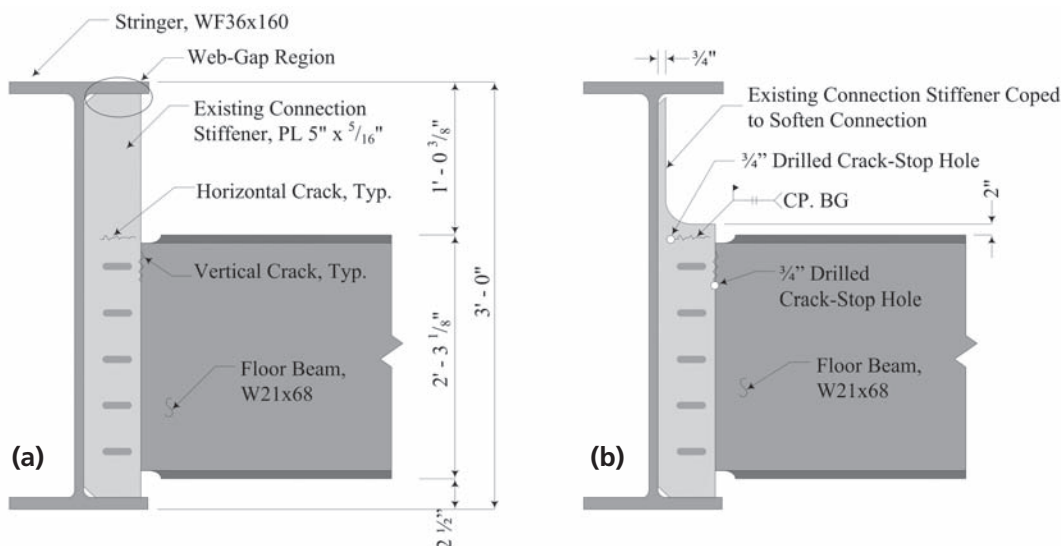

FIGURE 1 Little Arkansas River Bridge: (a) damaged floor beam to stringer connection; (b) repair performed.

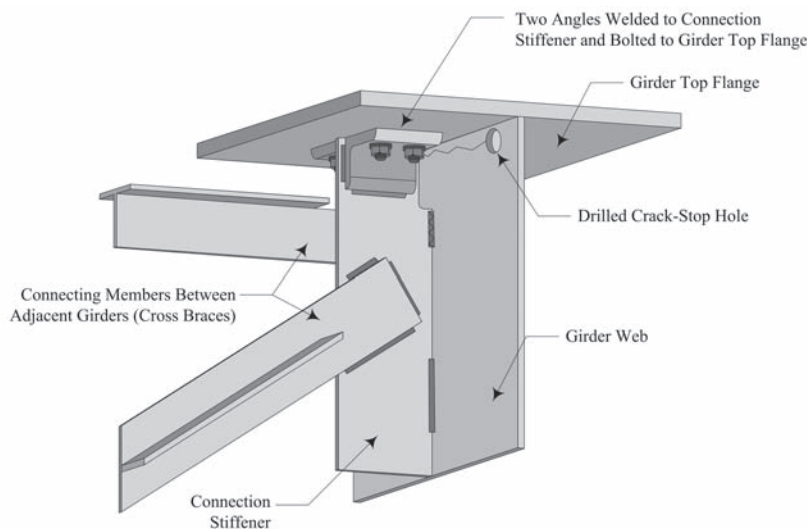

FIGURE 2 Repair and retrofit for Tuttle Creek Bridge.

Problem

Two Kansas highway bridges, K-96 over the Little Arkansas River in Hutchinson, and K-16 over the Tuttle Creek Reservoir in Riley County, revealed many distortion-induced fatigue cracks during several inspection cycles.

Constructed in 1955, the Little Arkansas River Bridge is a 17-span, 1,020-ft long, steel floor, beam-and-stringer structure. Cracking was found in the connecting plates between the stringers and floor beams, as shown in Figure 1.

The Tuttle Creek Bridge, constructed in 1962, is a 38-span structure, 5,350-ft long, with two girders. Figure 2 shows the typical cracking patterns found in the Tuttle Creek Bridge. Because the structure was nonredundant and fracture-critical, failure of a primary member could have caused a complete structural collapse; this heightened concerns about the cracking.

Solution

The University of Kansas (KU) and the KSBO formed a partnership to determine and evaluate retrofit solutions for each of the two bridges. The KSBO developed preliminary analytical models for initial understanding and for the retrofit development. KU evaluated the proposed repairs with sophisticated analysis tools and experimental field techniques. KU and Kansas DOT then partnered in field evaluations of each of the structures, before and after the repairs, to estimate the performance of the new details.

The Arkansas River Bridge repairs focused on reducing restraint in the damaged connections, after the KU analyses found that additional restraint would have concentrated forces at the horizontal welds and exacerbated the bridge's problems. The chosen retrofit is shown in Figure 1b.

KU also evaluated the repairs developed by the

KSBO for the Tuttle Creek Bridge. The repairs used angle sections to connect the stiffeners to the top flange of the girder, as shown in Figure 2. Threaded studs were welded to the bottom of the girder's top flange. Angle sections were welded to each side of the connection stiffener and were nutted to the threaded stud on the top flange. This detail offered two advantages: it could be installed without disrupting traffic, and it did not create a fatigue-prone detail on the primary member.

Benefits

The stress ranges in the repaired details at the Arkansas River Bridge decreased significantly, resulting in an estimated fatigue life of 25 to 65 years, depending on traffic. The repair work performed on the structure cost \$500,000, in contrast to the estimated \$5 million for bridge replacement, which also would have inconvenienced the traveling public.

The calculated fatigue life of the retrofitted details in the Tuttle Creek Bridge exceeds the useful life of the structure. The repair and retrofit work cost \$700,000, with bridge replacement estimates ranging from \$26.5 million to \$62.6 million. Because of the high cost of replacement, the only viable alternative to repair would have been closure, forcing residents to detour almost 50 miles.

Moreover, the repair to the Tuttle Creek Bridge could be performed under traffic. Many alternative repair methods commonly used to engage the top flange with the web-gap region require replacing part of the concrete bridge deck to allow access to the top of the top flange.

The benefits of this research partnership to the agency, taxpayers, and the traveling public were substantial. Repair was a much more economical alternative than replacement, and travelers and local residents did not have to make excessive—and possibly permanent—detours. These retrofit methods can be used on many Kansas bridges of similar design, as well as on other U.S. bridges with similar fatigue damage.

For more information, contact Caroline R. Bennett, Assistant Professor, University of Kansas, Department of Civil, Environmental, and Architectural Engineering, 2150 Learned Hall, 1530 West 15th Street, Lawrence, KS 66045-7609; telephone 785-864-3235; e-mail crb@ku.edu.

EDITOR'S NOTE: Appreciation is expressed to David Beal, Transportation Research Board, for his efforts in developing this article. Beal retired in November from TRB; the *TR News* editorial board thanks him for his contributions to the magazine's content and to the RPO Task Force.

Suggestions for "Research Pays Off" topics are welcome. Please contact G. P. Jayaprakash, Transportation Research Board, Keck 488, 500 Fifth Street, NW, Washington, DC 20001 (telephone 202-334-2952, e-mail gjayaprakash@nas.edu).

TRB Meetings 2009

January

11–15 TRB 88th Annual Meeting
Washington, D.C.

February

9–12 1st International Conference
on Transportation
Construction
Management*
Orlando, Florida

March

24–25 Midwest Traffic Monitoring
Workshop
Columbus, Ohio

April

7–8 Workshop on Polyphosphoric
Acid Modification of Asphalt
Binders*

19–22 11th Joint Light Rail Transit
Conference*
Los Angeles, California

21–23 Strategic Highway Safety Plan
and State DOT Safety
Engineer Peer Exchanges (*by
invitation*)
Chicago, Illinois
Richard Pain

22–24 National Conference on
Preservation, Repair, and
Rehabilitation of
Concrete Pavements*
St. Louis, Missouri

22–24 Teamwork in U.S. Railroad
Operations
Irvine, California
Richard Pain

May

TBD 4th Bus Rapid Transit
Conference*
Seattle, Washington
Peter Shaw

TBD Symposium on the
Transmission of Disease in
Airports and Aircraft
Washington, D.C.
Christine Gerencher

3–5 7th National Aviation System
Planning Symposium
Monterey, California

4–6 TRB Annual Ports,
Waterways, Freight, and
International Trade
Conference
Irvine, California
Joedy Cambridge

12–14 19th Biennial TRB Visibility
Symposium
Blacksburg, Virginia

17–21 12th National Transportation
Planning Applications
Conference
Houston, Texas

27–29 11th Annual Harbor Safety
Committee Conference*
Tampa, Florida
Joedy Cambridge

June

TBD North American
Transportation Statistics
Interchange (*by invitation*)
Washington, D.C.
Thomas Palmerlee

TBD Research Road Map for
Geospatial Information
Technologies for
Transportation (*by invitation*)
TBD
Thomas Palmerlee

2–3 Data on Goods Movement
Impacts on Air Quality
Workshop
Irvine, California
Thomas Palmerlee

21–24 2nd International Symposium
on Freeway and Tollway
Operations*
Honolulu, Hawaii

22–26 5th International Driving
Symposium on Human Factors
in Driver Assessment,
Training, and Vehicle Design*
Big Sky, Montana
Richard Pain

29–
July 2 8th International Conference
on the Bearing Capacity
of Roads, Roadways, and
Airfields*
Champaign, Illinois

July

TBD 12th AASHTO–TRB
Maintenance Management
Conference*
TBD, Maryland

8–10 6th International Conference
on Maintenance and
Rehabilitation of
Pavements and
Technological Control*
Politecnico, Di Tornio, Italy

Additional information on TRB meetings, including calls for abstracts, meeting registration, and hotel reservations, is available at www.TRB.org/calendar. To reach the TRB staff contacts, telephone 202-334-2934, fax 202-334-2003, or e-mail lkarson@nas.edu. Meetings listed without a TRB staff contact have direct links from the TRB calendar web page.

*TRB is cosponsor of the meeting.

James A. Wilding *Aviation Consultant*

Throughout his 43-year career in aviation engineering, planning, management, and research, consultant James Wilding has worked to build productive relationships with members of the aviation industry and has served as an effective advocate for U.S. airports in Congress, through his work with the Federal Aviation Administration (FAA) and the Metropolitan Washington Airports Authority (MWAA).

Wilding began his career in 1959, when he joined FAA to participate in the original planning and development effort for Washington–Dulles International airport. After the opening of the airport in 1962, Wilding held positions of increasing responsibility—including chief engineer—in all phases of engineering for both Washington–Dulles and Ronald Reagan–Washington

is also in a transformation process, and it is being redeveloped and expanded—continuing a tradition of long-range planning and of air service support.”

Active in TRB since the 1960s, Wilding chairs the Airport Cooperative Research Program (ACRP) Oversight Committee and is a member of the ACRP Project Panel on Transportation Planning for High-Density Corridors Linking Mega-Regions, as well as the National Cooperative Highway Research Program Project Panel on Transportation Response Options: Scenarios of Infectious Disease, Biological Agents, Chemical, Biological, Radiological, or Nuclear Exposure.

He is a past member of the TRB Executive Committee, the Subcommittee on Policy and Planning Review; the National Research Council (NRC)-appointed Committee on Science and

Technology for Countering Terrorism: Panel on Transportation; and the NRC-appointed Committee for Stakeholder Input in Developing the Airport System Management Services Component of the National Airspace System.

“I am a firm believer in the value of research,” Wilding asserts. “When ACRP started, we examined candidate topics that were seeking funding, and I came to appreciate how much I did not fully understand about the field in which I worked for more than 40 years. After more than 100 projects, we are making very good progress in thinking through some very important subjects.”

In addition to his volunteer work at TRB, Wilding has contributed his expertise to other professional organizations and has been an active participant in regional civic affairs. He has served as chair of the Airports Council International, North America; as president of the Aero Club of Washington, D.C.; and as a member of the Policy Review Committee of the American Association of Airport Executives. He also has chaired the United Way Campaign of Arlington, Virginia; served as a member of the Economic Development Commission of Arlington County; and has served on the board of directors and the executive committee of the Arlington Chamber of Commerce.

Wilding earned a bachelor’s degree in civil engineering from the Catholic University of America, Washington, D.C., in 1959. He has received many awards for his contributions to transportation, including the President’s Senior Executive Meritorious Service Award, 1982; the Secretary of Transportation’s Gold Medal, 1986; the Tower of Dulles Award, 1986; the Aero Club of Washington’s Aviation Excellence Award, 1997; the American Society of Civil Engineers’ OPAL Award for Lifetime Achievement, 2004; the Virginia Department of Aviation Lifetime Achievement Award, 2001; and the National Aeronautic Association Elder Statesman of Aviation Award, 2006.



“Being a part of the Metropolitan Washington Airports Authority as it transitioned from federal government ownership to an independent, regional authority is something I’m very proud of.”

National airports. In 1974, he assumed the position of deputy director for FAA’s Metropolitan Washington Airports organization, and in 1978 he took the position of director.

In June 1987, ownership of the airports was transferred to MWAA, and Wilding continued in his leadership role, serving as president and CEO of the organization—a position he held until his retirement in 2003. During his tenure, Wilding directed the growth and expansion of Washington-area airports. Ronald Reagan–Washington National was modernized, and a new terminal was opened in 1997, which aided in regional traffic management. At Washington–Dulles, Wilding guided the replanning of the airport, the development of the Eero Saarinen-designed main terminal, and the construction of new concourses and the airport’s first parking garages.

“Being a part of the Metropolitan Washington Airports Authority as it transitioned from federal government ownership to an independent, regional authority is something I’m very proud of,” explains Wilding. “Shortly after the transfer in 1987, I was involved with the multibillion-dollar development program that transformed Ronald Reagan–Washington National into a splendid, customer-oriented, and modern airport that is now a valued regional asset and a source of pride. Washington–Dulles

Robert B. Franklin

Telvent Farradyne

Robert “Tip” Franklin’s expertise in command and control systems and in decision support systems is the result of a 45-year career as a military officer and as a civilian professional in the field of transportation. A retired colonel, Franklin maintains that the 27 years he spent in the military—including command assignments and operations staff positions—prepared him for his work in the development and operation of traffic management by providing a solid foundation in “the systems engineering process and in the application of the decision support system philosophy.”

In his postmilitary career, Franklin has served as director of integrated transportation services for Serco, Inc.; director of business development for Viasys Services and for Lockheed Martin; program manager of the Georgia Navigator project; and



“The [Georgia] Navigator project proved that it was possible for government agencies to come together and manage traffic on a regional basis.”

as regional manager of the public safety–intelligent transportation systems (ITS) business development staff at TRW, Inc.

In October 2006, Franklin joined Telvent Farradyne as an area manager responsible for business development activities in Northern California and parts of Western Canada. He is also a project manager for the Bay Area Video Upgrade, assisting the California Department of Transportation (DOT) with improvements to the control system for all freeway-based, closed-circuit television surveillance cameras in the San Francisco area.

A personal and professional highlight for Franklin is his work as a project manager on the Georgia DOT Navigator advanced transportation management system, deployed to manage increases in traffic in the Atlanta metropolitan area during the 1996 Summer Olympics. One of the first multi-agency, multifunction ITS deployments, the traffic information system provides drivers with real-time traffic information through changeable message signs on Georgia’s busiest roads and through a free, statewide cellular phone service, available 24 hours a day.

“The Navigator project proved that it was possible for government agencies to come together and manage traffic on a

regional basis,” Franklin explains. “From a personal perspective, the successful development and deployment of the Navigator confirmed my belief that the principles of decision support system design, which I had observed in military operations, would be of great benefit in the ITS environment.”

Franklin has contributed his expertise to many professional organizations. He is an active member of the TRB Freeway Operations Committee, and he has attended TRB Annual Meetings since 1993. He is a member of the Transportation Security and Evacuation Advisory Committee and the Traffic Incident Management Committee. Franklin also serves on the Institute of Transportation Engineers–Transport Management Center Committee. He is a past chair of the Homeland Security Advisory Council Administration Transition Task Force, vice chair of the Pan America ITS Council, a member of the Business Leadership Council, and a past member of the public safety forum steering committee at ITS America. He also has served the International Bridge, Tunnel, and Turnpike Association, ITS Canada, and the Institute of Electrical and Electronics Engineers Standards Association.

“A large measure of the success of the federal ITS program has been TRB and its committee structure,” notes Franklin. “I have watched, participated in, and marveled at the Freeway Operations Committee’s impact on standards, operational procedures, and research and program support for ITS. The committee has done a wonderful job of identifying and supporting ITS research needs, interacting with other TRB committees and other professional associations, and has provided the support necessary to make the ITS program a reality.”

Franklin has contributed articles and papers on public safety and traffic management to ITS America, the ITS World Congress, *Traffic Technology International*, the Pan American ITS Council, and the European Transport Forum. He has held diverse teaching positions, with such institutions as the U.S. Army Armor School in Fort Knox, Kentucky, and Park College, Northern Virginia. He served as a standardization instructor pilot in Vietnam; Hanau, Germany; and Fort Knox, Kentucky, and he was director of academic development of the U.S. Army’s Armor Training Brigade.

Franklin earned a bachelor’s degree in marketing and a master’s degree in business administration from Ohio State University, Columbus, in 1963 and 1973, respectively, and he has completed coursework in contingency operations and operations planning at the U.S. Army War College, Carlisle, Pennsylvania.

Optimistic Outlook for Bridge Funding

More than 60 percent of highway professionals are optimistic about reducing the number of structurally deficient and functionally obsolete bridges in the United States, according to a recent *Better Roads* magazine survey of departments of transportation in 50 states and the District of Columbia.

The findings from the survey provide up-to-date data on bridge conditions and indicate that increased funding for bridge construction and repair has contributed to the outlook for 2009. Survey data indicate that 56 percent of bridges in the District of Columbia are in need of repair, followed by 53 percent of bridges in Rhode Island; 42 percent in Kentucky; 39

percent in Hawaii; 37 percent in New York; 36 percent in Massachusetts, Vermont, and Connecticut; 31 percent in North Carolina and New Hampshire; and 30 percent in Missouri, Louisiana, and Oklahoma.

States with the lowest percentage of deficient and obsolete bridges include Arizona (10 percent); Nevada (11 percent); Wyoming (12 percent); Minnesota (13 percent); Colorado, Texas, and Utah (14 percent); Wisconsin, (15 percent); and New Mexico (17 percent).

To view the complete 2008 *Better Roads bridge inventory*, visit <http://obr.gcnpublishing.com/articles/bridgeinv08.htm>.

Air Traffic Controllers Receive Virtual Training

The Federal Aviation Administration (FAA) is using electronic tower simulators to train air traffic controllers at its Federal Aviation Academy. The virtual simulators will aid in training the projected 1,700 controllers to be hired each year for the next 12 years, will reduce the numbers of trainees in towers and radar rooms, and will trim training times by 20 to 60 percent.

The Aviation Academy operates six simulators for 18 hours per day and can provide trainees with an immersive electronic training experience that includes shifts in time of day and changes in weather. The simulator-based training is supplemented with older training methods that use wooden model planes in a classroom setting.

Since 1990, the Aviation Academy increasingly has computerized its screening process—candidates must

complete a computer-based aptitude test, as well as participate in electronic games that test hand-eye coordination, memory, multitasking, situational awareness, flexibility in decision making, composure under stress, and tolerance to interruptions.

In addition to the units at the Aviation Academy, FAA will deploy simulators at airports in 19 locations, including New York; Los Angeles and Oakland, California; Washington, D.C.; Dallas–Fort Worth and San Antonio, Texas; Atlanta, Georgia; Denver, Colorado; Philadelphia, Pennsylvania; Cincinnati and Cleveland, Ohio; Memphis, Tennessee; Honolulu, Hawaii; Orlando, Florida; Charlotte, North Carolina; Minneapolis, Minnesota; Boston, Massachusetts; and Newport News, Virginia.

For more information, visit http://www.faa.gov/news/press_releases/news_story.cfm?newsId=10157.

HIGH-TECH TRANSIT—A display screen provides traffic signal priority information aboard a bus at the Vehicle Infrastructure Integration Demonstration at the 15th World Congress on Intelligent Transportation Systems, in New York, in November.

For the demonstration, attendees boarded one of six buses operating on a test bed in Manhattan and on the Long Island Expressway. The buses were outfitted with dedicated short-range communications technologies, which provided traveler information; probe data; signal phase timing and transit

signal priority information; traffic signal preemption, and more. The system integration and coordination for the buses—as well as the probe data and mass transit priority and traffic signal preemption applications for the onboard equipment—were provided by Southwest Research Institute, San Antonio, Texas.

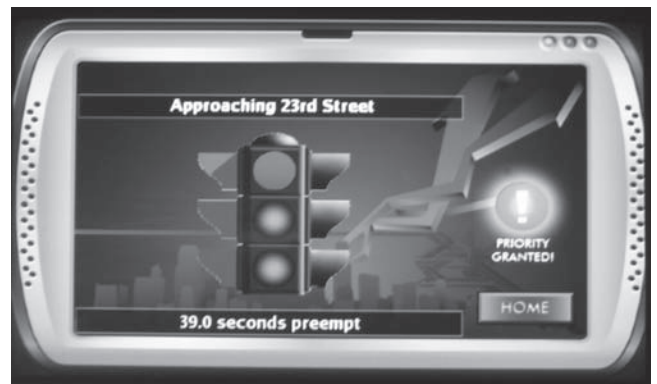



MARINE BOARD SETS COURSE—During a session of the Marine Board Fall Meeting at the National Academies’ Keck Center, new Board members joined with continuing members to develop activities of interest to sponsoring agencies for 2009–2010, including the Minerals Management Service; the National Oceanic and Atmospheric Administration; and the U.S. Maritime Administration, Coast Guard, Army Corps of Engineers, and Navy. Participants included (*left photo, left to*



right) Jerry Bridges, Virginia Port Authority; James Card, U.S. Coast Guard, retired; Mary Brooks, Dalhousie University; Fred Harris, NASSCO—General Dynamics; and Steve Carmel, Maersk Line, all new members; and (*right photo, background to foreground*) Ken Arnold, National Academy of Engineering; Ron Kiss, Consultant; new member Tom Leschine, University of Washington; Judy Harris, City of Portland, Maine; and John Waggoner, Hornblower Marine.

COOPERATIVE RESEARCH PROGRAMS NEWS

Guidelines for Ramp and Interchange Spacing

Freeway interchanges provide reasonable access and mobility to motorists but can greatly diminish the traffic operations, safety, and capacity of through-lanes. Research indicates that a majority of freeway accidents occur at interchanges and in weaving sections of road set between closely-spaced entrance and exit ramps.

To balance the provision of service and access with safety and operations in the construction of new freeways and interchanges, transportation agencies require a clear understanding of the

impacts of ramp and interchange spacing on safety and operations. Kittelson and Associates has been awarded a \$500,000, 30-month contract [National Cooperative Highway Research Program (NCHRP) 03-88, FY 2008] to develop guidelines for selecting appropriate highway ramp and interchange spacing based on potential safety and operational impacts. The project is scheduled for completion in December 2010.

For more information, contact Chris Hedges, TRB, 202-334-1472, chedges@nas.edu.

Specifications for Freight Data Architecture

Public and private freight transportation decision makers require a broad understanding of freight movement to respond to pressing transportation issues. Integrating freight data elements into a comprehensive program can be complicated by large volumes of data; the statistical challenges of linking the data elements; understanding what the data represent; proprietary interests; and national security concerns; and the consequences of inaction or lack of data.

Studies and conferences sponsored by TRB and the Cooperative Research Programs have called for a national freight data architecture to link data sets and to guide data collection. The Texas Trans-

portation Institute has been awarded a \$300,000, 18-month contract [National Cooperative Freight Research Program (NCFRP) 12, FY 2008] to evaluate the development of a freight data architecture; integrate freight data for public and private decision making; define the benefits of a national freight data architecture, as well as the challenges of preparing it; specify the institutional strategies to build and support a sustainable architecture; and assess and discuss the sustainable long-term benefits of an architecture that supports the identification and resolution of problems.

For more information, contact Bill Rogers, TRB, 202-334-1621, wrogers@nas.edu.

Comparative Performance Measurement: Pavement Smoothness

American Association of State Highway and Transportation Officials (AASHTO), 2008; 76 pp.; \$15; 1-56051-424-4.

Smooth pavement can reduce vehicle operating costs and is valued by travelers and shippers. Because all U.S. states must report International Roughness Index data for roads in the National Highway System, pavement smoothness is an important performance measure for state departments of transportation.

The second in a series of reports for the AASHTO Subcommittee on Performance Measurement and Benchmarking of the Standing Committee on Quality, this publication identifies and documents the best practices of states that have achieved exemplary performance in smooth pavements.

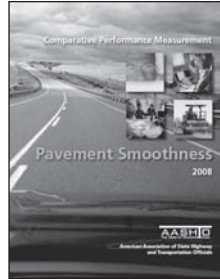

ments, and methods of measurement and payment. Supporting material is included on a CD-ROM.

Round Table 139: Oil Dependence: Is Transport Running Out of Affordable Fuel?

Organization for Economic Cooperation and Development, 2008; 210 pp.; \$81; 978-92-821-0121-6.

Because developing economies require increasing amounts of oil for transportation, limited fluctuations in transportation oil demand can have significant effects on oil prices. The market power of the Organization of Petroleum Exporting Countries (OPEC) is increasing, and production of conventional oil outside of OPEC has reached a plateau.

Included in this Round Table is an examination of factors that drive oil prices in the short and long term, as well as a discussion on the outlook for future oil supplies. Policy instruments for assessing oil security and climate change are investigated, and their interactions with congestion and air pollution mitigation measures are examined.

Guide Specifications for Highway Construction, 9th Edition

AASHTO, 2008; 474 pp.; AASHTO members, \$130; nonmembers, \$156; 1-56051-378-0.

The 9th edition guidebook complements AASHTO load and resistance factor design specifications for major structures and bridges and includes new sections. Sections 312–315 address additional base course options; sections 716–718 present information on materials requirements for aluminum, timber, and ground anchors; and Appendixes A and B provide sample technical provisions and considerations for use with innovative contracting methods and pavement ride quality measurement.

Also provided are expanded state-to-state and outside agency cross references, as well as uniformity of nomenclature, materials, construction require-

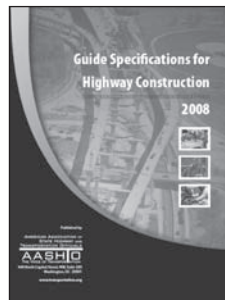

The Limits to Travel: How Far Will You Go?

David Metz. Earthscan, 2008; 164 pp.; \$79.95; 978-1-84407-493-8.

In 9 chapters, author Metz—a visiting professor at the Centre for Transport Studies, University College, London, and a former chief scientist at the Department of Transport, United Kingdom—explores why people travel, how they use transportation systems, the environmental impacts of increasing travel demand, and the limits to travel.

Also discussed is the effect of affluence on travel speed and distance; the impacts of the rapid increase in automobile use in developing nations, including China and India; and problems that accompany the expansion of worldwide transportation systems—including pollution, congestion, noise, and anthropogenic climate change.

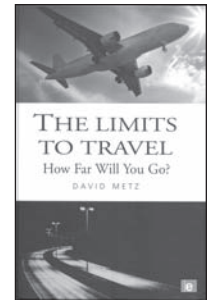

The books in this section are not TRB publications. To order, contact the publisher listed.

TRB PUBLICATIONS

Multi-Objective Optimization for Bridge Management Systems

NCHRP Report 590

Described are the methodologies for network- and project-level optimization of multiple, user-specified performance criteria and their development, as well as bridge management software modules required for implementation.

2007; 130 pp.; TRB affiliates, \$44.25; nonaffiliates,

\$59. Subscriber category: bridges, other structures, and hydraulics and hydrology (IIC).

Simplified Live Load Distribution Factor Equations

NCHRP Report 592

This report includes recommended load and resistance factor design (LRFD) live-load distribution factor design equations for shear and moment. The

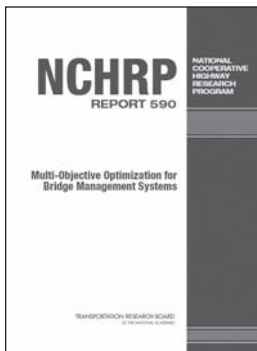

TRB PUBLICATIONS (continued)

development of new and simple equations with a wide range of applicability is presented in detail.

2007; 127 pp.; TRB affiliates, \$36.75; nonaffiliates, \$49. Subscriber category: bridges, other structures, and hydraulics and hydrology (IIC).

Countermeasures to Protect Bridge Piers from Scour

NCHRP Report 593

Practical selection criteria for bridge-pier scour countermeasures; guidelines and specifications for the design and construction of countermeasures; and guidelines for inspection, maintenance, and performance evaluation are described.

2007; 272 pp.; TRB affiliates, \$45; nonaffiliates, \$60. Subscriber categories: planning and administration (IA); bridges, other structures, and hydraulics and hydrology (IIC); materials, construction, and maintenance (III).

Guidebook for Integrating Freight into Transportation Planning and Project Selection Processes

NCHRP Report 594

A framework is developed for incorporating freight needs for all modes in transportation planning and priority programming by state, regional, metropolitan, local, and special transportation agencies. Also explored are technical issues, organizational suggestions, and communications requirements for freight planning and programming.

2007; 186 pp.; TRB affiliates, \$38.35; nonaffiliates, \$51. Subscriber categories: planning, administration, and environment (I); operations and safety (IV); freight transportation (VIII); marine transportation (IX).

Application of the LRFD Bridge Design Specifications to High-Strength Structural Concrete: Flexure and Compression Provisions

NCHRP Report 595

Presented is research on revisions to AASHTO's LRFD bridge design specifications, and on extending the applicability of flexural and compression design provisions for reinforced and prestressed concrete members to strengths greater than 10 ksi.

2007; 28 pp.; TRB affiliates, \$24; nonaffiliates, \$32. Subscriber category: bridges, other structures, and hydraulics and hydrology (IIC).

Rotation Limits for Elastomeric Bearings

NCHRP Report 596

This report explores the elastomeric bearing design procedures suitable for adoption in AASHTO's LRFD specifications.

2008; 55 pp.; TRB affiliates, \$27; nonaffiliates, \$36. Subscriber category: bridges, other structures, and hydraulics and hydrology (IIC).

Development of a Recommended Practice for Use of Controlled Low-Strength Material in Highway Construction

NCHRP Report 597

The use of controlled low-strength material (CLSM) in highway construction—as backfill, utility bedding, void fill, and bridge approaches—is explored, and information on a field-tested procedure for the use of CLSM is included.

2008; 150 pp.; TRB affiliates, \$41.25; nonaffiliates, \$55. Subscriber category: pavement design, management, and performance (IIB).

Performance-Related Tests of Recycled Aggregates for Use in Unbound Pavement Layers

NCHRP Report 598

Performance-related procedures to test and select recycled hot-mix asphalt and portland cement concrete materials for use in unbound layers of highway pavements are presented. Appendixes A through C—which cover the literature review and background information, new aggregate tests, and surface dielectric measurements—were also published as NCHRP Web-Only Document 119.

2008; 53 pp.; TRB affiliates, \$30; nonaffiliates, \$40. Subscriber categories: pavement design, management, and performance (IIB); materials and construction (IIIB).

Default Values for Highway Capacity and Level of Service Analyses

NCHRP Report 599

This report examines the selection of default values in analyzing highway capacity and level of service, as well as ways to prepare service volume tables.

2008; 124 pp.; TRB affiliates, \$39; nonaffiliates, \$52. Subscriber category: planning and administration (IA).

Calibration and Validation of the Enhanced Integrated Climatic Model for Pavement Design

NCHRP Report 602

Described are the evaluation, calibration, and validation of the Enhanced Integrated Climatic Model incorporated into Version 0.7 of the *Mechanistic-Empirical Pavement Design Guide* software, as well as measured materials data from the Long-Term Pavement Performance Seasonal Monitoring Program pavement sections.

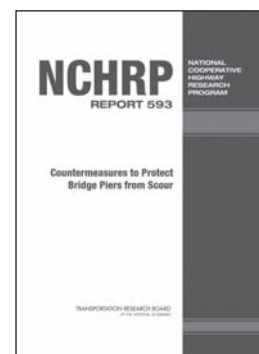

TRB PUBLICATIONS (continued)

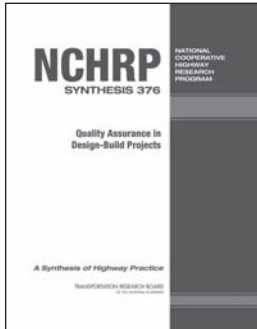

2008; 62 pp.; TRB affiliates, \$31; nonaffiliates, \$42. Subscriber category: pavement design, management, and performance (IIB).

Transfer, Development, and Splice Length for Strand/Reinforcement in High-Strength Concrete
NCHRP Report 603

Examined are revisions to AASHTO's LRFD bridge design specifications, to extend the applicability of the transfer, development, and splice length provisions for prestressed and nonprestressed concrete members to concrete strengths greater than 10 ksi.

2008; 122 pp.; TRB affiliates, \$39; nonaffiliates, \$52. Subscriber category: bridges, other structures, and hydraulics and hydrology (IIC).

Heat-Straightening Repair of Damaged Steel Bridge Girders: Fatigue and Fracture Performance
NCHRP Report 604

The fatigue and fracture performance of steel bridge girders that have been repaired by heat-straightening procedures is investigated, to determine the maximum number of damage and repair cycles.

2008; 129 pp.; TRB affiliates, \$39.75; nonaffiliates, \$53. Subscriber categories: bridges, other structures, and hydraulics and hydrology (IIC); maintenance (IIIC).

Passing Sight Distance Criteria
NCHRP Report 605

Methods are presented for determining the minimum requirements for passing sight distance (PSD), along with recommendations to ensure consistency between PSD design standards and pavement marking practices.

2008; 85 pp.; TRB affiliates, \$32.25; nonaffiliates, \$43. Subscriber categories: highway and facility design (IIA); highway operations, capacity, and traffic control (IVA).

Specifications and Protocols for Acceptance Tests on Processing Additions in Cement Manufacturing
NCHRP Report 607

This report addresses changes to the cement specifications and test protocols in AASHTO's *Standard Specifications for Transportation Materials and Methods of Sampling and Testing*. A recommendation is included for evaluating processing additions in amounts that exceed those specified.

2008; 86 pp.; TRB affiliates, \$37.50; TRB nonaffiliates, \$50. Subscriber category: materials and construction (IIIB).

GASB 34—Methods for Condition Assessment and Preservation
NCHRP Report 608

Methodologies that integrate infrastructure inventory, condition assessments, minimum acceptable condition levels, and funding decisions with the reporting requirements of the Governmental Accounting Standards Board (GASB) Statement No. 34 are analyzed. Also investigated are the operational and financial impacts of reporting under GASB 34.

2008; 125 pp.; TRB affiliates, \$39; nonaffiliates, \$52. Subscriber category: planning and administration (IA).

Quality Assurance in Design-Build Projects
NCHRP Synthesis 376

This synthesis examines successful ways that state transportation agencies have approached quality assurance for design-build, including applications for procurement, design, construction, and post-construction operations and maintenance.

2008; 130 pp.; TRB affiliates, \$40.50; nonaffiliates, \$54. Subscriber categories: pavement design, management, and performance (IIB); materials and construction (IIIB).

Employee Compensation Guidelines for Transit Providers in Rural and Small Urban Areas
TCRP Report 127

Salary and benefit characteristics of transit systems in rural and small urban areas are evaluated. An interactive computer tool, produced through this project, is available online to allow transit managers to obtain compensation and benefit data quickly and easily from comparable transit systems.

2008; 204 pp.; TRB affiliates, \$45; nonaffiliates, \$60. Subscriber categories: planning and administration (IA); public transit (VI).

Impact of Airport Pavement Deicing Products on Aircraft and Airfield Infrastructure
ACRP Synthesis 6

Chemical treatment of airport pavements to mitigate snow and ice is explored. Also examined are the effects of pavement deicing products on aircraft and airfield infrastructure.

2008; 58 pp.; TRB affiliates, \$31.50; nonaffiliates, \$42. Subscriber category: aviation (V).

Airport Economic Impact Methods and Models
ACRP Synthesis 7

Airport economic impact studies are examined, along with the methods and models used to define and identify, evaluate, measure, and communicate the economic impacts of airports.

TRB PUBLICATIONS (continued)

2008; 67 pp.; TRB affiliates, \$33.75; nonaffiliates, \$45. *Subscriber category: aviation (V).*

Geomaterials 2007**Transportation Research Record 2026**

Divided into three parts—Part 1: Effect of Geomaterial Properties on Performance of Transportation Infrastructure; Part 2: Stabilization of Soils and Geomaterials; Part 3: New Mechanistic–Empirical Pavement Design Guide: Stabilized Material Characterization—this volume includes peer-reviewed papers on such topics as fiber reinforcement of soft clay soils, the effects of reclaimed asphalt pavement and cement on the strength and durability of recycled aggregate base materials, concrete sludge powder for soil stabilization, and more.

2007; 88 pp.; TRB affiliates, \$36.75; nonaffiliates, \$49. *Subscriber category: soils, geology, and foundations (IIIA).*

Highway Capacity and Quality of Service**Transportation Research Record 2027**

Authors address such topics as a stochastic concept for highway capacity analysis; a new method for evaluating transportation service quality using a fuzzy aggregation and a cultural consensus technique; an empirically calibrated theoretical model for the estimation of total approach capacity at signalized intersections; a point-detection method to measure approach delay at signalized intersections; and headway acceptance characteristics of U-turning vehicles at unsignalized intersections.

2007; 114 pp.; TRB affiliates, \$39; nonaffiliates, \$52. *Subscriber category: highway operations, capacity, and traffic control (IVA).*

Design of Structures 2007**Transportation Research Record 2028**

Divided into six parts—General Structures, Steel Bridges, Concrete Bridges, Dynamics and Field Testing of Bridges, Seismic Design of Bridges, Culverts and Hydraulic Structures, and Structural Fiber-Reinforced Polymers—this volume includes papers on modeling the effects of cracks on chloride ingress in bridge decks with epoxy-coated reinforced steel; structured public involvement in context-sensitive large bridge design using casewise visual evaluation; the application of the Hilbert–Huang transform for the time–frequency analysis of nonstationary impact echo data; and more.

2007; 237 pp.; TRB affiliates, \$49.50; nonaffiliates, \$66. *Subscriber category: bridges, other structures, and hydraulics and hydrology (IIC).*

Network Equilibrium Modeling 2007**Transportation Research Record 2029**

This volume presents findings on equilibrium solutions in single-bottleneck traffic models with homogenous travelers who have the same preferred arrival times; properties of a doubly dynamic simulation assignment model; a model for designing transportation networks under uncertainty about future demands; the redesign of the Dutch road network using an optimization algorithm; and more.

2007; 95 pp.; TRB affiliates, \$36.75; nonaffiliates, \$49. *Subscriber category: planning and administration (IA).*

Traffic Control Devices, Visibility, and**Rail–Highway Grade Crossings 2007****Transportation Research Record 2030**

Included are papers on factors that influence the level of perceptible sound generated by an automobile tire striking a rumble strip; an alternative typeface for urban wayfinding signs in Miami Beach, Florida; design standards for speed cushions; updating guidelines for minimum traffic signal sight distance; drivers' preference for headlight swivel angles on curved sections of road; reducing unsafe actions by motor vehicle operators at gated railroad–highway grade crossings; and more.

2007; 84 pp.; TRB affiliates, \$35.25; nonaffiliates, \$47. *Subscriber category: highway operations, capacity, and traffic control (IVA).*

Bicycles and Motorcycles**Transportation Research Record 2031**

The development of a macrolevel bicyclist intersection safety index; a network analysis tool to improve real and perceived bicycle safety to quantify the bicycle-friendliness of a street network; a model for predicting how bicyclists perceive the arterial roadway environment; the effectiveness of motorcycle training and education on reducing accident rates; and mobility patterns of motorcycle and moped operators in Greece are some of the research topics in this volume.

2007; 75 pp.; TRB affiliates, \$34.50; nonaffiliates, \$46. *Subscriber category: safety and human performance (IVB).*

Commercial Fleet and**Transit Network Modeling 2007****Transportation Research Record 2032**

Authors address subjects that include a dynamic freight network simulation–assignment platform for the analysis of multiproduct intermodal freight transportation systems; the use of real-time information in



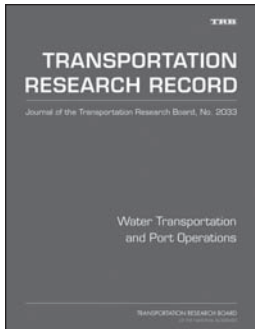

TRB PUBLICATIONS (continued)

decision making for less-than-truckload carriers in a dynamic environment; a multiobjective optimum path algorithm for passenger pretrip planning in multimodal transportation networks; a method for analyzing how the restriction of rest locations for long-haul truckers may affect operational productivity; and more.

2007; 62 pp.; TRB affiliates, \$33.75; nonaffiliates, \$45. Subscriber category: *planning and administration (IA)*.

Water Transportation and Port Operations

Transportation Research Record 2033

Included are papers on a stated preference technique for the analysis of container port competition and the feasibility of hub port implementation in China; the optimization of an internal transport cycle for a marine container terminal managed by straddle carriers; characteristics of truck drayage operations at the Port of Houston, Texas; potential economic gains from inland water transport development in India; and estimating the effects of changing service times and lock closures with an elastic demand relationship in a waterway simulation model.

2007; 61 pp.; TRB affiliates, \$33.75; nonaffiliates, \$45. Subscriber category: *marine transportation (IX)*.

Transit: Marketing, Bus, and Paratransit

Transportation Research Record 2034

This three-part volume presents research on video transit training for residents of a senior adult community in California; the effects of individual and environmental factors on the perception of bus and train safety in Chicago, Illinois; the applicability of the Bogotá, Colombia, TransMilenio bus rapid transit system model to cities in the United States; predicting bus arrival times on a service route using Global Positioning System data; an adaptive traffic signal priority strategy for buses in Minneapolis, Minnesota; and negative experiences and user loyalty in paratransit service.

2007; 142 pp.; TRB affiliates, \$41.25; nonaffiliates, \$55. Subscriber category: *public transit (VI)*.

Traffic Signal Systems and Regional Transportation Systems Management 2007

Transportation Research Record 2035

Authors present findings on a real-time adaptive control algorithm for tuning traffic signal offsets in a coordinated traffic signal system; modeling traffic signal operations with precedence graphs; the application of diamond interchange signal control strategies at six closely-spaced intersections in Reno,

Nevada; techniques for real-time measurement of vehicle delay and queue length at a signalized intersection; implementation of lane-by-lane detection at an actuated, controlled intersection in Noblesville, Indiana; a probabilistic approach to optimizing traffic signal timing; and more.

2007; 215 pp.; TRB affiliates, \$48; nonaffiliates, \$64. Subscriber category: *highway operations, capacity, and traffic control (IVA)*.

Strategic Management and Productivity 2007

Transportation Research Record 2036

Part 1 contains the 2007 Thomas B. Deen Distinguished Lecture by Genevieve Giuliano on the changing landscape of transportation policy and investment decision making. Part 2 includes research on a methodological framework for analyzing institutional settings in transportation policy making; a case study of the Transportation Academy at the University of Massachusetts, Amherst; and a case study of the Technology Transfer Program Training Project at the University of California, Berkeley.

2007; 66 pp.; TRB affiliates, \$34.50; nonaffiliates, \$46. Subscriber category: *planning and administration (IA)*.

Rigid and Flexible Pavement Design 2007

Transportation Research Record 2037

This volume is divided into two parts. Part 1: Rigid Pavements contains papers on the variations in crack widths over time in three continuously reinforced concrete pavement projects in Texas, as well as experimental and analytical investigations on the effects of dowel misalignment on joint opening behavior and distress in concrete pavement joints. Part 2: Flexible Pavements offers findings on the development of a simplified design procedure for determining layer thickness in pavements with a design life of more than 40 years, and the development and influence of statewide axle load spectra on flexible pavement performance in Arkansas.

2007; 142 pp.; TRB affiliates, \$41.25; nonaffiliates, \$55. Subscriber category: *pavement design, management, and performance (IIB)*.

The TRR Journal Online website provides electronic access to the full text of more than 9,000 peer-reviewed papers that have been published as part of the Transportation Research Board (TRR Journal) series since 1996. The site includes the latest in search technologies and is updated as new TRR Journal papers become available. To explore the TRR Online service, visit www.TRB.org/TRROnline.

To order TRB titles described in Bookshelf, visit the TRB online Bookstore, at www.TRB.org/bookstore/, or contact the Business Office at 202-334-3213.

INFORMATION FOR CONTRIBUTORS TO

TR NEWS

TR News welcomes the submission of manuscripts for possible publication in the categories listed below. All manuscripts submitted are subject to review by the Editorial Board and other reviewers to determine suitability for *TR News*; authors will be advised of acceptance of articles with or without revision. All manuscripts accepted for publication are subject to editing for conciseness and appropriate language and style. Authors receive a copy of the edited manuscript for review. Original artwork is returned only on request.

FEATURES are timely articles of interest to transportation professionals, including administrators, planners, researchers, and practitioners in government, academia, and industry. Articles are encouraged on innovations and state-of-the-art practices pertaining to transportation research and development in all modes (highways and bridges, public transit, aviation, rail, and others, such as pipelines, bicycles, pedestrians, etc.) and in all subject areas (planning and administration, design, materials and construction, facility maintenance, traffic control, safety, geology, law, environmental concerns, energy, etc.). Manuscripts should be no longer than 3,000 to 4,000 words (12 to 16 double-spaced, typed pages). Authors also should provide appropriate and professionally drawn line drawings, charts, or tables, and glossy, black-and-white, high-quality photographs with corresponding captions. Prospective authors are encouraged to submit a summary or outline of a proposed article for preliminary review.

RESEARCH PAYS OFF highlights research projects, studies, demonstrations, and improved methods or processes that provide innovative, cost-effective solutions to important transportation-related problems in all modes, whether they pertain to improved transport of people and goods or provision of better facilities and equipment that permits such transport. Articles should describe cases in which the application of project findings has resulted in benefits to transportation agencies or to the public, or in which substantial benefits are expected. Articles (approximately 750 to 1,000 words) should delineate the problem, research, and benefits, and be accompanied by one or two illustrations that may improve a reader's understanding of the article.

NEWS BRIEFS are short (100- to 750-word) items of interest and usually are not attributed to an author. They may be either text or photographs or a combination of both. Line drawings, charts, or tables may be used where appropriate. Articles may be related to construction, administration, planning, design, operations, maintenance, research, legal matters, or applications of special interest. Articles involving brand names or names of manufacturers may be determined to be inappropriate; however, no endorsement by TRB is implied when such information appears. Foreign news articles should describe projects or methods that have universal instead of local application.

POINT OF VIEW is an occasional series of authored opinions on current transportation issues. Articles (1,000 to 2,000 words) may be submitted with appropriate, high-quality illustrations, and are subject to review and editing. Readers are also invited to submit comments on published points of view.

CALENDAR covers (a) TRB-sponsored conferences, workshops, and symposia, and (b) functions sponsored by other agencies of interest to readers. Notices of meetings should be submitted at least 4 to 6 months before the event.

BOOKSHELF announces publications in the transportation field. Abstracts (100 to 200 words) should include title, author, publisher, address at which publication may be obtained, number of pages, price, and ISBN. Publishers are invited to submit copies of new publications for announcement.

LETTERS provide readers with the opportunity to comment on the information and views expressed in published articles, TRB activities, or transportation matters in general. All letters must be signed and contain constructive comments. Letters may be edited for style and space considerations.

SUBMISSION REQUIREMENTS: Manuscripts submitted for possible publication in *TR News* and any correspondence on editorial matters should be sent to the Director, Publications Office, Transportation Research Board, 500 Fifth Street, NW, Washington, DC 20001, telephone 202-334-2972, or e-mail jawan@nas.edu.

- ◆ All manuscripts should be supplied in 12-point type, double-spaced, in Microsoft Word 6.0 or WordPerfect 6.1 or higher versions, on a diskette or as an e-mail attachment.

- ◆ Submit original artwork if possible. Glossy, high-quality black-and-white photographs, color photographs, and slides are acceptable. Digital continuous-tone images must be submitted as TIFF or JPEG files and must be at least 3 in. by 5 in. with a resolution of 300 dpi or greater. A caption should be supplied for each graphic element.

- ◆ Use the units of measurement from the research described and provide conversions in parentheses, as appropriate. The International System of Units (SI), the updated version of the metric system, is preferred. In the text, the SI units should be followed, when appropriate, by the U.S. customary equivalent units in parentheses. In figures and tables, the base unit conversions should be provided in a footnote.

NOTE: Authors are responsible for the authenticity of their articles and for obtaining written permissions from publishers or persons who own the copyright to any previously published or copyrighted material used in the articles.

Transportation, Energy, and Climate Change

The twin issues of energy and climate change are among the most significant public policy issues facing the transportation profession, not only today but in the coming decades. To address these challenges, it is critical to develop and share knowledge and experiences on ways to mitigate the adverse impacts of transportation on energy and climate, and to adapt transportation to the realities of a new energy and climate change environment.

TRB has examined a variety of issues related to transportation, energy, and climate change. In addition to a website that highlights activities of TRB in the area of climate change (<http://trb.org/climatechange>), TRB has developed a bookshelf of resources to inform transportation professionals, decision makers, and members of the general public. Here are some of the latest energy and climate change titles produced by TRB and other parts of the National Academies:



Potential Impacts of Climate Change on U.S. Transportation

<http://books.trbbookstore.org/sr290.aspx>

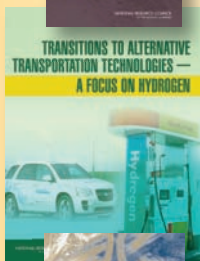

Transitions to Alternative Transportation Technologies: A Focus on Hydrogen

http://www.nap.edu/catalog.php?record_id=12222



Review of the Research Program of the FreedomCAR and Fuel Partnership: Second Report

http://www.nap.edu/catalog.php?record_id=12113



What You Need to Know About Energy

http://www.nap.edu/catalog.php?record_id=12204

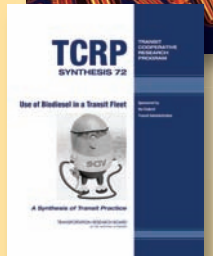

Use of Biodiesel in a Transit Fleet

<http://books.trbbookstore.org/ts072.aspx>



Review of the 21st Century Truck Partnership

http://www.nap.edu/catalog.php?record_id=12258



Understanding and Responding to Climate Change: Highlights of National Academies Reports, 2008 Edition

http://dels.nas.edu/dels/rpt_briefs/climate_change_2008_final.pdf

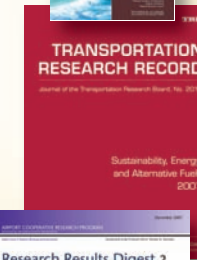

Sustainability, Energy, and Alternative Fuels 2007

<http://books.trbbookstore.org/r2017.aspx>



Model for Improving Energy Use in U.S. Airport Facilities

<http://books.trbbookstore.org/ad02.aspx>

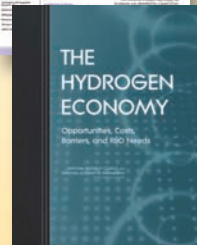

The Hydrogen Economy: Opportunities, Costs, Barriers, and R&D Needs

http://www.nap.edu/catalog.php?record_id=10922



Additional transportation, energy, and climate change publications are available through the TRB Bookstore at www.TRB.org/bookstore or through National Academies Press at www.nap.edu. Be sure to visit the TRB climate change website, <http://trb.org/climatechange>.

THE NATIONAL ACADEMIES™

Advisers to the Nation on Science, Engineering, and Medicine

The nation turns to the National Academies—National Academy of Sciences, National Academy of Engineering, Institute of Medicine, and National Research Council—for independent, objective advice on issues that affect people's lives worldwide.

www.national-academies.org